



READ AND SAVE THESE INSTRUCTIONS

Commercial Fabric Steamer Owner's Guide

LEA Y GUARDAR ESTAS INSTRUCCIONES

Guía Para El Propietario Del Vaporizador Comercial De Telas

LISEZ ET CONSERVEZ CES INSTRUCTIONS

Mode D'emploi – Défroiseur Commercial À Vapeur Pour Tissus

www.vornadocommercial.com

Serial# _____

Write number here for warranty purposes.

Escriba el número de serie aquí para la garantía.

Écrivez le série numéro ici aux fins de la garantie.

model VS-570

Contents

Designed, engineered and supported
in Andover, Kansas.

Questions or comments?



www.vornadocommercial.com



support@vornadocommercial.com



888.232.9490

Important Instructions	4
The Vornado Difference	5
Assembly	6
Product Information	8
How to Use	9
Steam Level Recommendations.....	10
Storage.....	11
Cleaning	11
Troubleshooting	13
Return Policy	13
Replacement Parts and Accessories.....	14
Warranty.....	15

Español p. 18
Français p. 34

Downtime is Not An Option

Your Vornado VS-570 is built to perform flawlessly, even in the most challenging commercial environments. In the unlikely event that you experience an issue, Vornado is committed to getting you up and running as quickly and easily as possible. Register your product online at www.vornadocommercial.com to take advantage of Vornado's premium 24 hour turnaround service.



Free Repair or Replacement

We believe in taking full responsibility for manufacturing defects – so we'll resolve any issue arising from defective product during the warranty period – free of charge. If the damage is not covered by the warranty, or if the product is out of warranty, we'll promptly notify you before proceeding, to ensure you're aware of any costs that may arise.



Free Shipping – Both Ways*

Call in or visit www.vornadocommercial.com to initiate your return shipment. We'll send a prepaid shipping label to get the process started, and cover the costs of returning the unit to you with Standard Ground Shipping.



24 Hour Turnaround**

Once the product is received and inspected by our technicians, you will be contacted with confirmation of warranty repair service or a repair estimate. Once service is authorized, we will turn around your repair or schedule a full replacement within 24 hours.

*Standard Ground Shipping is Free during warranty coverage with product registration. Standard shipping fees will apply to non-warranty repairs.

**Once service is authorized, Vornado will repair and ship your product within 24 hours. If there is a service fee, we will arrange quick payment with you in order to expedite the return of your product. Payment must be received before shipment.

IMPORTANT INSTRUCTIONS

READ AND SAVE THESE INSTRUCTIONS

WARNING: To reduce risk of fire, electrical shock or injury, the following basic safety precautions should always be followed when using an electrical appliance.

WARNING: Before plugging unit into electrical outlet, be sure all electrical information on the rating label agrees with your power supply.

DANGER: Any appliance is electrically live even when switched Off. To reduce risk of electrical shock:

1. Always unplug power cord immediately after using.
 2. Do not place, immerse or drop into water or other liquid.
 3. If unit falls into water, immediately unplug power cord. Do not reach into the water.
- Use Commercial Fabric Steamer only for its intended purpose as indicated in this manual.
 - **Do Not** direct steam at people or animals.
 - Unplug from wall when not in use.
 - **Do Not** leave unattended.
 - **Do Not** expose to rain.
 - **Do Not** use with damaged cord or plug.
 - **Do Not** store outdoors.
 - **Do Not** use if unit has been dropped.
 - **Do Not** handle with wet hands.
 - **Do Not** pull or carry by cord.
 - Not to be used as a toy.
 - Never put de-scaling, aromatic, alcoholic or detergent products into unit.

- Close attention is necessary when used near children.
- Danger of scalding - emits very hot steam.
- **Do Not** put any objects into openings.
- **Do Not** put hands or feet in steam.
- Not for space heating purposes.
- **Do Not** use an extension cord.
- Only use on flat, horizontal surfaces.
- Never turn unit on it's side during use.
- To avoid circuit overload, do not operate another appliance on the same electrical circuit.
- **Do Not** use on leather, wax polished furniture or floors or other delicate, steam sensitive materials.
- **Do Not** use unit where aerosol-based products are being used, or where oxygen is being administered.

WARNING: This Commercial Fabric Steamer is for use on 120V grounded outlets ONLY.

Trust.

It is said that trust isn't given, but earned. For decades Vornado has been earning the trust of our customers by offering them only the best. Vornado provides the highest level of performance, coupled with the highest level of support available. Complete satisfaction with no exceptions – this is Vornado's promise to you. If you are not satisfied for any reason, please contact us. Knowledgeable representatives are available at 1-888-232-9490 from 7:00 AM to 6:00 PM CST. A wealth of additional support is also available online at www.vornadocommercial.com. On behalf of myself and the entire staff at our Andover, Kansas headquarters – thank you for selecting Vornado.

Sincerely,
Randy Brillhart
CEO, Vornado Air



Find our complete product line at www.vornadocommercial.com

The Vornado Difference

Certified Commercial Grade Steam Care™

ETL Listed for Commercial Use.

Built for Commercial Use. Perfect for use at home.

Industry Leading Features

- 2 Steam Settings
- 5.5' Steam Hose Length
- 10' Power Cord Length
- Convenient Cord Management
- Adjustable 70" Pole Height
- Protective Silicone Bumper
- Easy To Roll Caster Wheels

2 MIN
HEAT UP
TIME

4 HOUR
CONTINUOUS
STEAM*

1500
WATTS

1 GAL
WATER
TANK

3 YEAR
LIMITED
WARRANTY

Learn more about your
Commercial Fabric Steamer.



VS-570

*On low Steam Level.

Assembly

What You Will Need:

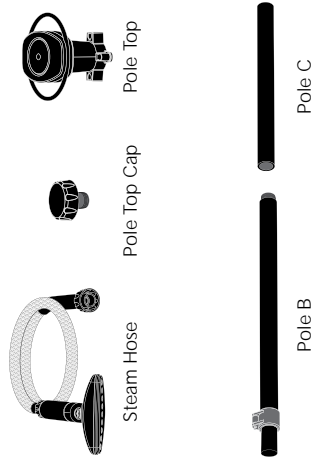

If any parts are missing, contact Consumer Service at 1-888-232-9490.

Installing the Pole:

- 1.** Push the Pole Top onto Pole B and tighten using the Pole Top Cap (A) (Figure 1).
- 2.** Assemble Pole B into Pole C and screw together clockwise to connect. (Figure 2).

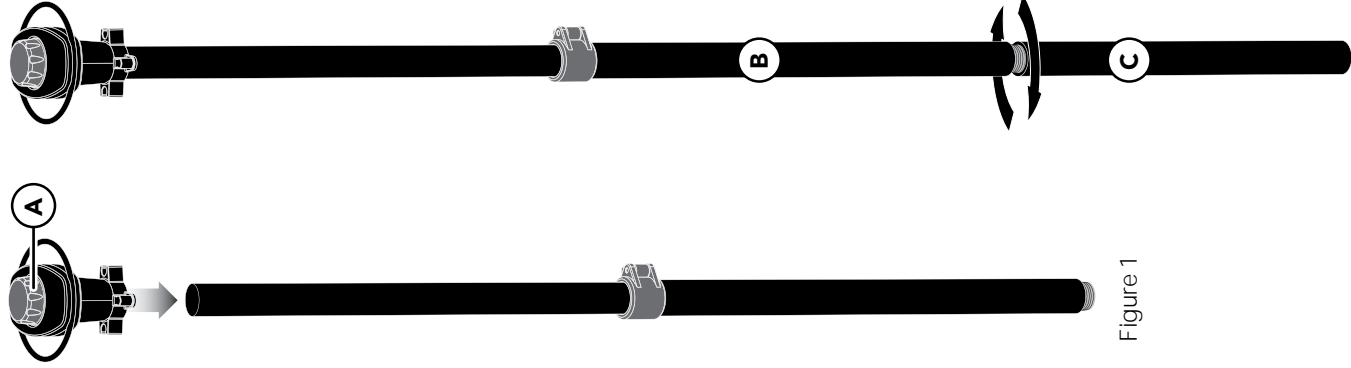

Figure 1

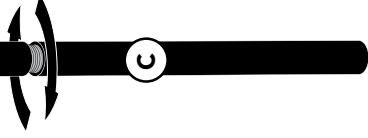

Figure 2

- 3.** Insert Pole C into unit through Coupling (D). Screw Coupling (D) clockwise until Pole C is secured (Figure 3).

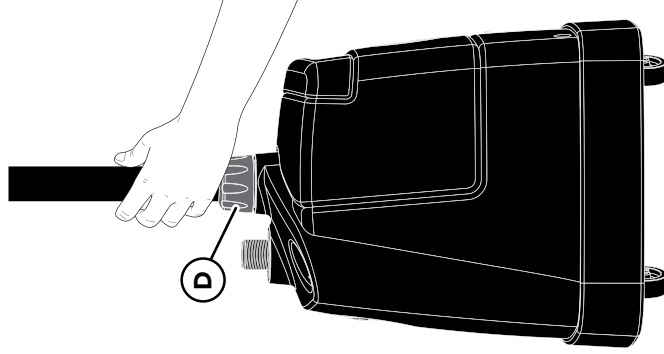

Figure 3

- Installing the Steam Hose**
- 1.** Screw Hose Coupling (E) clockwise onto unit steam outlet until tight (Figure 4).

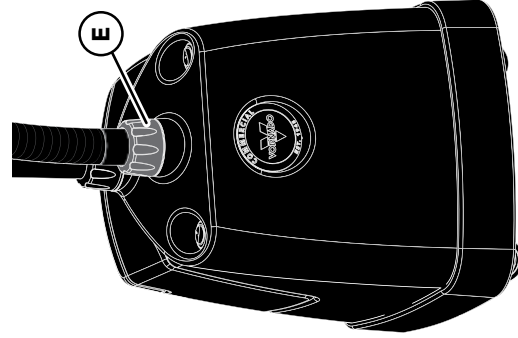

Figure 4

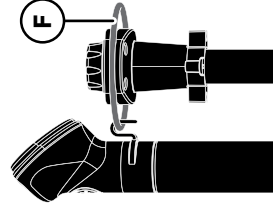

Figure 5

Note: If coupling is not tight, water and steam can leak from this opening.

- 2.** Hang the Fabric Nozzle onto the Hanger Ring (F) (Figure 5).

Product Information



Installing Water Tank

1. Remove Water Tank. Remove Water Tank Cap and fill Water Tank with water. Replace Water Tank Cap and reinstall Water Tank.

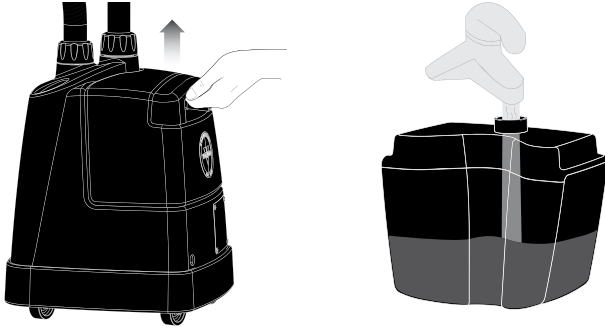

Tip Using distilled or demineralized water will maximize the life and performance of the unit.

CAUTION: Do not allow steamer to run dry. Unit may overheat causing the over-temp fuse to actuate, if this occurs see TROUBLESHOOTING on page 13.

Operation

1. Unwrap power cord and plug into 120V grounded outlet.

Note: Extension cords are not recommended.

2. Press Power Switch to On (I) position.

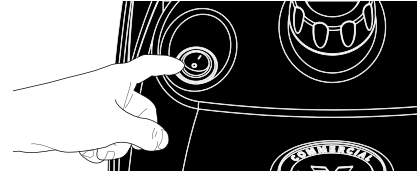

3. Choose desired Steam Level by pressing Steam Level Switch.

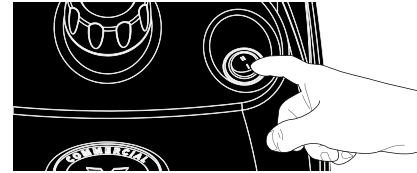

Tip See STEAM LEVEL RECOMMENDATIONS on page 10 for fabric tips.

Note: The unit may take up to 2 minutes to produce steam. Be careful of hot steam at all times. During operation, the Steam Hose may make a gurgling noise, refer to TROUBLESHOOTING on page 13.

How To Use

WARNING: When steaming delicate fabrics such as silk or velvet, do not let the Fabric Nozzle touch the fabric directly.

4. Hang Fabric Nozzle in an upright position on the Hanger Ring.



Note: To prevent water overflow in the reservoir, fully extend the Adjustable Pole when resting the Fabric Nozzle on the Hanger Ring for an extended period of time.

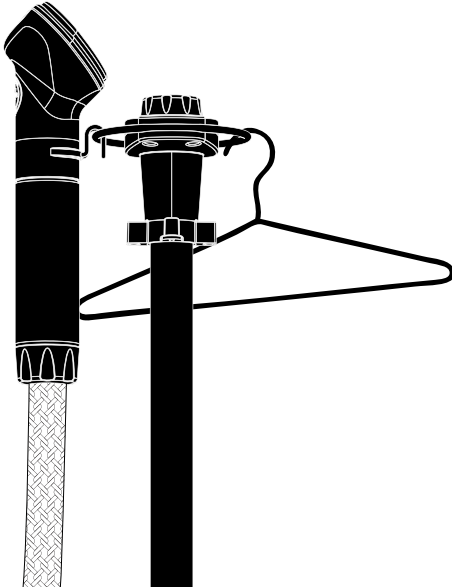

Steam Level Recommendations

Low I		High II	
<ul style="list-style-type: none">• Silk• Satin• Embroidery• Sequins• Synthetic	<ul style="list-style-type: none">• Polyester• Nylon• Rayon• Wool	<ul style="list-style-type: none">• Cotton• Acrylic	<ul style="list-style-type: none">• Linen• Denim

- Check the fabric care label for manufacturer recommendations. Test the fabric on an unobtrusive area such as an inner seam.
- Test the strength of the color of the fabric on an area of the fabric that is not visible (inside of a hem).
- Heavy fabrics may need to be steamed longer and on High Steam Level.



Certain fabrics are smoothed more easily from the inside of the fabric.

Storage

1. Press Power Switch Off (O). Unplug Power Cord and secure to Cord Management.

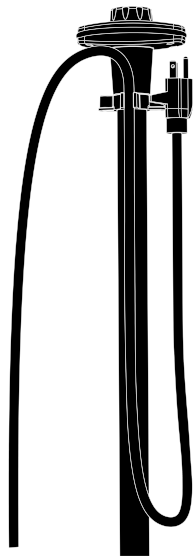

2. Allow unit to cool at least 30 minutes. Empty Water Tank, all residual water from reservoir and clean external surface with dry cloth. Allow to dry completely.
3. Store in a cool, dry location.

Cleaning

The cleaning steps below are required to maintain maximum performance of your unit. Cleaning is necessary every 3 to 6 months depending on the mineral content of your water.

1. Unplug unit and let unit cool at least 30 minutes.

WARNING: Danger of scalding if unit has not cooled for at least 30 minutes.

2. Remove Steam Hose, Pole and Water Tank from unit. Empty all residual water from reservoir.

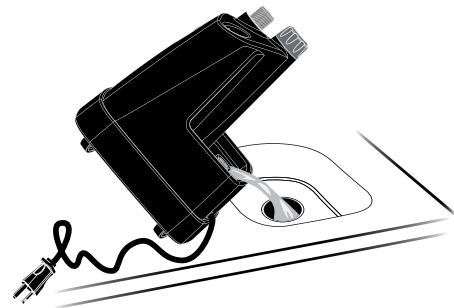

3. Remove and rinse the Removable Water Reservoir Cup.
4. Mix contents of 1 Cleaning Crystal packet with 4 oz. of hot water and mix until Cleaning Crystals completely dissolve.



+



CleanCycle Cleaning
Crystal Packet
(2 included)

WARNING: Avoid contact with skin. After use, thoroughly wash any container or utensils used. See Cleaning Crystal packet for additional warnings.

Cleaning

5. Pour solution into Steam Outlet. Reinstall Steam Hose and place Fabric Nozzle in sink. Plug in unit, press Power Switch On and set Steam Level to **LOW** and run unit for 5 minutes.

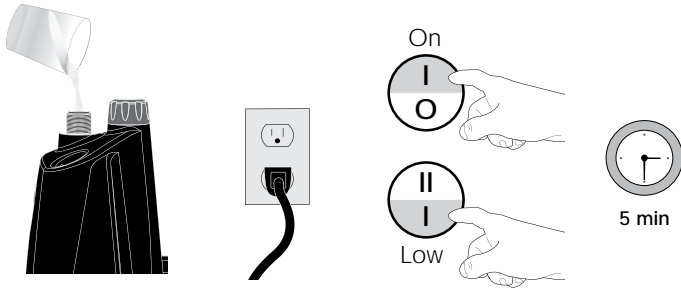

WARNING: Do not touch Fabric Nozzle. Hot steam will be emitted during the cleaning process.

6. Power unit Off and unplug. Let cleaning solution sit in unit for **1 hour**. Remove Steam Hose and empty all water through Steam Outlet.

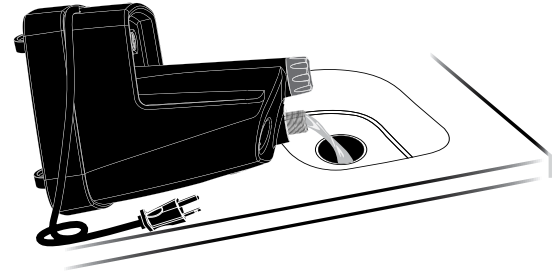

7. Rinse unit by pouring 2 cups of water into Steam Outlet. Empty all rinse water through Steam Outlet. Repeat until rinse water is clear with no particulate.

WARNING: Do not leave the Cleaning Crystal solution in unit. It may harm fabrics while steaming.

8. Rinse Steam Hose by placing entire hose into a sink. Pour 2 cups of water into Hose Coupling. Empty all rinse water through Hose Coupling.
9. Wipe top of plastic reservoir with a clean cloth, removing mineral build up.
10. Re-install Removable Water Reservoir Cup, Steam Hose, Pole and Water Tank. **The unit is now ready for use.**

Problem	Possible Cause and Solution
Commercial Fabric Steamer is not operating.	Power Switch is not illuminated. Press Power Switch and it should illuminate red indicating power is On.
	Steamer is not plugged in properly. Ensure plug fits firmly into outlet.
	Breaker or fuse that unit is plugged into is blown. Make sure Commercial Fabric Steamer is the only appliance plugged into that circuit and reset breaker or replace fuse.
	Unit has overheated and over-temp fuse has blown. Contact Consumer Service for repair.
Commercial Fabric Steamer does not emit steam during use or steam output is weak.	Water Tank is empty. Fill Water Tank with water.
	Mineral build up in unit. Unit needs to be cleaned. Refer to CLEANING on page 11.
	Hose may be kinked. Lift Fabric Nozzle until there is no bend in the Steam Hose.
Water left on fabric.	Allow more space between Fabric Nozzle and fabric.
	Use the Low Steam Level.
Gurgling noise from Steam Hose.	Lift Fabric Nozzle until there is no bend in the Steam Hose. Change to the Low Steam Setting if gurgling noise is too loud.

Vornado Air, LLC Steam Product Return Policy

Thank you for your interest in Vornado Air, LLC steam products. Should this product fail to meet your expectations, you may return the product to Vornado Air, LLC for a refund, subject to the terms and conditions of this return policy.

This return policy applies to Vornado Air, LLC steam products purchased directly from Vornado Air, LLC and is independent of other dealer return policies. To receive a full product refund, not to include shipping charges, the steam product must be returned in new condition, in its original packaging, within 30 days of purchase. You will be required to provide the original sales receipt or invoice for purposes of verifying date of purchase.

Prior to shipping the product, you must contact the Vornado Air, LLC service department at 1-888-232-9490 or via email at support@vornadocommercial.com to obtain a Return Authorization ("RA") form and specific instructions on how to package and ship the steam product to avoid damage. Once the steam product is returned in new condition in its original packaging and an inspection by our technicians confirms compliance with the above requirements, you will be contacted regarding refund procedures.

Please contact a customer service representative at 1-888-232-9490 with any questions or concerns.

Replacement Parts and Accessories

Refer to the part numbers below when ordering parts and accessories for your Commercial Fabric Steamer.

Replacement Accessories

Part Numbers for Fast Reordering at www.vornadocommercial.com

Cleaning Crystals A110-006

Replacement Parts

Available www.vornadocommercial.com or via Vornado Consumer Service at 1-888-232-9490:

Water Tank with Cap	T570-P001
Water Tank Cap	T570-P002
Bottom Pole	T570-P006
Adjusting Pole	T570-P007
Pole Coupling	T570-P008
Pole Top	T570-P009
Pole Top Cap	T570-P010
Steam Hose	T570-P011
Wheel Caster (1 each)	T570-P012
Removable Water Reservoir Cup	T570-P013



Your Accessories, Shipped Free To Your Door

A convenient and hassle-free way to receive regular shipments of Vornado Accessories, direct to your door! Eliminate the hassle of remembering to reorder. Maintain the high efficiency of your Vornado Commercial Fabric Steamer by regularly replacing used Accessories with fresh new ones. How it works: You select a plan and Vornado will send replacement Accessories at a schedule that you can customize to your needs. Plus, shipping is free and you can change your schedule or cancel at anytime.

To sign up, visit www.vornadocommercial.com, email support@vornadocommercial.com or call 1-888-232-9490.

When ordering accessories and parts for your Commercial Fabric Steamer through Consumer Service, refer to the part numbers listed. Accessories and parts may also be ordered through our website.

Note: Due to continuing improvements, part numbers listed may change. For assistance ordering parts, please contact Consumer Service.



Commercial Fabric Steamer • 3 Year Limited Warranty

What is covered

Subject to the terms and conditions of this 3-Year Limited Commercial Warranty ("Warranty") as set forth below, Vornado Air, LLC ("Vornado") warrants to the original commercial purchaser ("Buyer") that this VS-570 Commercial Fabric Steamer (the "Product") is to be free from defects in material and workmanship for a period of three (3) years from the date of purchase when used and maintained in accordance with the Owner's Guide (the "Warranty Period"). In the event Buyer notifies Vornado of a defect in the Product within the Warranty Period, Vornado will, at its sole option and discretion, repair or replace the Product. Such repairs or replacement will be made at no charge to Buyer for parts or labor or for shipping and transportation costs associated with returning the Product to Vornado for covered repairs or replacement.

What is not covered

This Warranty shall not be applicable to damage or loss caused in whole or in part by:

- Repairs, modifications or alterations to the Product by anyone other than Vornado.
- Use or operation of the Product outside the permitted or intended uses described by Vornado in the Owner's Guide, or other careless operation,

handling, misuse, or abuse of the Product.

- Lack of proper maintenance of the Product as specified in the Owner's Guide.
- Use of the Product other than for normal commercial purposes.
- Normal wear and tear.
- Use of attachments other than those produced or recommended by Vornado.
- Cosmetic damage, such as scratches, nicks and dents.
- Damage caused by accident, water, flood, fire or other acts of nature or external causes.

Warranty limitations and exclusions

NO OTHER EXPRESS OR IMPLIED WARRANTY IS GIVEN BY VORNADO TO BUYER AND NO REPRESENTATIVE HAS THE AUTHORITY TO MAKE REPRESENTATIONS OTHER THAN THOSE PROVIDED HEREIN. THERE ARE NO WARRANTIES WHICH EXTEND BEYOND THE DESCRIPTION ON THE FACE HEREOF. ALL OTHER IMPLIED WARRANTIES, INCLUDING, BUT NOT LIMITED TO, THE IMPLIED WARRANTIES OF MERCHANTABILITY AND FITNESS FOR A PARTICULAR PURPOSE, ARE LIMITED IN DURATION TO THE DURATION OF THIS WARRANTY. VORNADO'S REPAIR OR REPLACEMENT OF THE PRODUCT IS THE EXCLUSIVE REMEDY. UNDER NO CIRCUMSTANCES SHALL VORNADO BE LIABLE TO BUYER OR ANY OTHER PERSON FOR ANY

Warranty

INCIDENTAL, SPECIAL, CONSEQUENTIAL, OR OTHER DAMAGES, EVEN IF VORNADO HAS BEEN ADVISED OF OR COULD REASONABLY FORESEE THE POSSIBILITY OF SUCH DAMAGES, INCLUDING, BUT NOT LIMITED TO, LOSS OF PROFITS OR DAMAGE, WHETHER ARISING OUT OF BREACH OF WARRANTY, BREACH OF CONTRACT OR UNDER ANY OTHER THEORY OF LAW.

How do you register the Warranty

Buyer must complete an application to register this Warranty within forty-five (45) days following date of purchase. Buyer may either visit Vornado's website at www.vornadocommercial.com and complete an online application or mail a completed application to:

Vornado Air, LLC
Attn: Warranty Registration
415 E. 13th Street
Andover, KS 67002

Failure to register this Warranty within forty-five (45) days following date of purchase will render this Warranty null and void.

Warranty service

For warranty or repair service, call 1-888-232-9490 or email support@vornadocommercial.com to obtain a Return Authorization ("RA") form. Include the Product model number and serial number, as well as Buyer's name, address, city, state, zip code and phone number when contacting Vornado for warranty service. Buyer may be required to provide the original sales receipt or invoice for purposes of verifying date of purchase.

After receiving the RA form, the Product must be shipped to:

Vornado Air, LLC
Attn: Warranty & Repair
415 E. 13th Street
Andover, KS 67002

To ensure proper handling, packages must be clearly marked with the RA number. Packages not clearly marked with the RA number may be refused at the receiving dock. The Product should be carefully packed to avoid damage in shipping. Damage in shipping is not covered by the Warranty and shall be the sole responsibility of Buyer.

Upon receipt of the Product, Vornado will inspect the Product to confirm coverage under the Warranty. If the Product is defective and covered by the Warranty, it will be repaired or replaced as provided in this Warranty and returned to Buyer free of charge. Damage or loss not covered by this Warranty or occurring outside the Warranty Period will require a fee to cover the cost of repairs and materials at Vornado's then-current rates, plus a fee to cover the cost of shipping and handling. All such fees and costs shall be the sole responsibility of Buyer. Buyer will be notified via mail of the cost of repairs and amount due and Buyer must remit payment of all required fees and costs prior to completion of repair and return shipment of the Product. All non-warranty repair work completed and paid for as set forth above is warranted to be free from defects in material and workmanship for a period of one (1) year from the date of completion of such work and otherwise in accordance with the terms and conditions of this Warranty.

Notes



Vornado Air, LLC
415 East 13th Street, Andover, Kansas 67002
888.232.9490 | www.vornadocommercial.com

Speak your mind www.vornadocommercial.com/reviews
Denos su opinión en www.vornadocommercial.com/reviews
Exprimez vos pensées www.vornadocommercial.com/reviews