



Owner's Handbook

read & save these important instructions

manual del propietario

lea y guarde estas instrucciones importantes

mode d'emploi

lire et conserver ces instructions importantes



HELLO, I'M
Huey

nursery evaporative humidifier

Hola, me llamo Huey, humidificador evaporativo vivero.

Bonjour, je suis le Huey, humidificateur par évaporation de pépinière.

Welcome to Vornadobaby

Thank you for choosing to put a Vornadobaby product in your nursery. Our goal is to provide healthy, comfortable air - through every season. Vornado has been doing this for quite a while now. We've brought all our experience in air health and comfort, and tailored it exclusively for your nursery.

A THIRD
generation
NAME

Vornado



vornadobaby™

Vornado began in 1945, continues to revolutionize airflow today and is now tailored for the nursery.

Contents

Important Instructions.....	4	Warranty.....	25
Safety.....	6		
Huey Controls.....	7		
Plug In & Placement.....	8		
Using Huey For The First Time	10		
Huey Water Bottle	11		
How To Use.....	13		
Changing Huey's Wick.....	14		
Extending Wick Life	16		
Keeping Huey Clean	17		
Tips	22		
Troubleshooting	23		

IMPORTANT INSTRUCTIONS

READ ALL INSTRUCTIONS BEFORE USING.

Please visually inspect all internal and external components before connecting to electric current. If any damage is found, DO NOT USE THIS UNIT and contact Vornado Air LLC at 1-800-234-0604.

This appliance has a polarized plug. (One blade is wider than the other.) To reduce the risk of electrical shock, this plug is intended to fit in a polarized outlet only one way. If the plug does not fit fully in the outlet, reverse the plug. If it still does not fit, contact a qualified electrician. Do not attempt to defeat this safety feature.

When using electrical appliances, basic precautions should always be followed to reduce the risk of fire, electrical shock and injury to persons, including the following:

- Do Read all instructions before using this Humidifier.
- Do Turn the Humidifier off if the relative humidity exceeds 60%. Humidity levels above 60% may allow moisture to build up indoors and condense on surfaces, where microorganisms can settle and grow. For accurate humidity readings, use

a hygrometer which is available at most hardware stores and home centers.

- Do Unplug the Humidifier prior to moving, cleaning or refilling.
- Do Unplug and empty this Humidifier when not in operation.
- Always unplug when not in use or when leaving the dwelling or premises for extended periods of time.
- Do Empty water from the Humidifier if the Humidifier is to be turned off and left for more than 8 hours, as leaving the water will encourage the growth of microorganisms. If this happens, thoroughly clean and disinfect the Humidifier. (Refer to the KEEPING HUEY CLEAN.)
- Do Remove the Water Bottle first if you need to move the Humidifier to another location.
- This Humidifier requires periodic cleaning. Refer to the KEEPING HUEY CLEAN instructions provided. **Do Not** clean the Humidifier in any manner other than as instructed in this manual.
- **Do Not** use this product on an uneven surface. Always place this product on a firm, flat surface.
- **Do Not** operate the Humidifier with a damaged cord or plug, after the Humidifier malfunctions, or has been dropped or damaged in any manner. If the supply cord is damaged, it must be replaced by the manufacturer, its service agent or similarly qualified persons in order to avoid a hazard.
- **Do Not** run power cord under carpeting.
- **Do Not** cover cord with throw rugs, runners or similar objects. Arrange the power cord away from traffic areas, so it will not become a tripping hazard.

- **Do Not** place the Humidifier near heat sources such as stoves, radiators or heaters.
- **Do Not** pour water through the top Outlet Air Grill on the Power Head.
- **Do Not** use undiluted bleach or ammonia, strong detergents, abrasive cleansers, gasoline, paint thinner or other solvents to clean this Humidifier. Use only water and mild detergents to perform daily maintenance on your Humidifier.
- **Do Not** ATTEMPT TO DISASSEMBLE THE POWER HEAD. DOING SO WILL VOID YOUR WARRANTY AND COULD CAUSE DAMAGE AND/OR PERSONAL INJURY. The Power Head contains no user serviceable parts. If you experience a problem, please see the limited warranty for information.
- **Do Not** repeatedly remove and replace the Water Bottle. This will overflow the Base and water will spill out.
- Humidifiers should be kept away from children and not be placed in a child's room without supervision.
- Do use common sense when using this product and/or any electrical appliance. This appliance is not intended for use by persons (including children) with a reduced physical, sensory or mental capabilities, or lack of experience and knowledge, unless they have been given supervision or instruction concerning use of the appliance by a person responsible for their safety. Children should be supervised to ensure that they do not play with the appliance.

Note: This equipment has been tested and found to comply with the limits for Class B digital device, pursuant to part 15 of the FCC Rules. These limits are designed to provide reasonable

protection against harmful interference in a residential installation. This equipment generates, uses and can radiate radio frequency energy and, if not installed and used in accordance with the instructions, may cause harmful interference to radio or television reception, which can be determined by turning the equipment off and on, the user is encouraged to try to correct the interference by one or more of the following measures:

- Reorient or relocate the receiving antenna.
- Increase the separation between the equipment and the receiver.
- Connect the equipment into an outlet on a circuit different from that to which the receiver is connected.
- Consult the dealer or an experienced radio/TV technician for help.

This device complies with part 15 of the FCC Rules. Operation is subject to the following two conditions: (1) This device may not cause harmful interference, and (2) this device must accept any interference received, including interference that may cause undesired operation.

Industry Canada ICES-003 Compliance: CAN ICES-3 (B)/NMB-3(B)

Warning: Changes or modifications to this unit not expressly approved by the party responsible for compliance could void the user's authority to operate the equipment.

READ AND SAVE THESE INSTRUCTIONS

Safety

Plug It In Safely! Your Huey has a 6 ft. power cord. Vornado recommends placing product as close to an outlet as possible and securing the remaining cord.



Locking Controls

Keep Huey Off when not in use or lock in your desired settings.



Enclosed Water Bottle

Protected on all sides from tampering toddlers.



Finger Friendly Design

Resists curious fingers.



Topple-Resistant Spill-Proof Wide Base

Resists splashing and spills.



Ergonomic Water Bottle

Easy to fill. Easy to carry. Easy to load.



Power Cord Wrap

Secured power cord prevents strangulation hazard.

Huey Controls



① Power (⏻)

② Humidity (💧💧)

③ Fan (🌀 - ● Low, ● High)

④ Control Lock (🔒)

Plug In & Placement

Power Cord Wrap

For your convenience and safety the power cord has a Power Cord Wrap to keep the power cord neat and out of harms way.

1. First, release the Power Cord Wrap around the power cord and unwind the power cord to desired length.
2. Close the Power Cord Wrap until any unwanted power cord is securely wrapped.

Safety Tip: Power cords increase strangulation risks. Secure the power cord inside the Power Cord Wrap as much as possible.

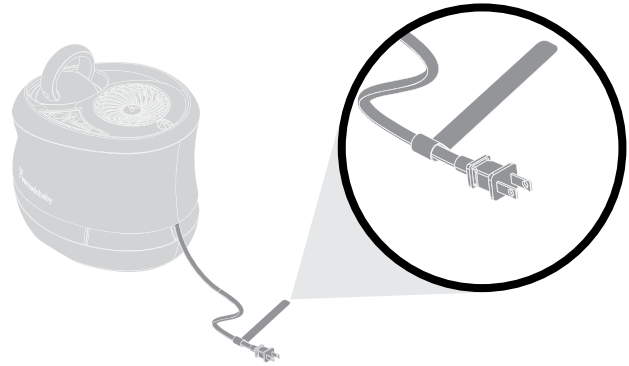

Set Up

1. Always lift Huey from the bottom.

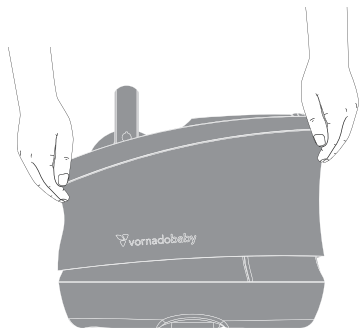
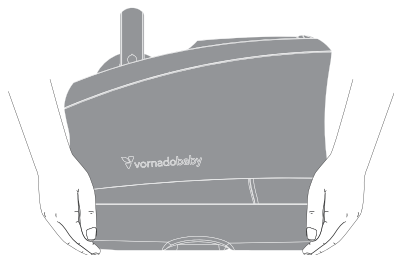

2. Position Huey to not blow directly on any objects.

Safety Tip: It is best to position Huey close to the power outlet and store excess power cord within the Power Cord Wrap.



Using Huey For The First Time

Your new Huey uses a sizable volume of water, so we recommend checking the Base and Water Bottle for leaks that may have occurred due to damage caused in shipping.

Note: A visual inspection may not reveal hairline fractures.

To Check For Leaks:

1. Place Huey on a water-resistant surface.
2. Remove and fill the Water Bottle with water to inspect for leaks.
3. Replace Water Bottle and inspect the base of Huey for leaks.

Leaking?

In the slight chance your Huey has leaks, contact Consumer Services and we will immediately replace damaged parts.

- On first use, the Wick may give off a mild odor. The odor is not harmful and will go away after the first few hours of operation.
Warning: Do not add oils or scents.
- Once Huey has reached the desired humidity in the room, it is normal for the fan to come back on periodically to take a sample of the room's humidity level. This is to maintain a more accurate humidity reading in the room.
- Allow for optimum airflow by keeping the grill unobstructed. Ensure curtains and other items are far enough away from Huey to not be pulled into the side inlets or interfere with airflow.
- We recommend you operate your Huey continuously. This helps maintain humidity all day long, costs only pennies a day, and will not harm Huey.
- Lower humidity control settings or turn off Huey if moisture forms on walls or windows.

Huey Water Bottle

Huey's Water Bottle will glow to notify you when water level is low.

It is recommended to refill the Water Bottle at this time to maintain humidity level in the room.

To give you a little time, Huey's Bottle illuminates before it is completely empty. Huey also stores water in his base, giving busy parents a bit more time to refill.

This notification will appear after approximately 12 hours, depending on use.

Running Huey without water will Not cause damage.



Huey Water Bottle

Refilling the Water Bottle

1. Remove Water Bottle.

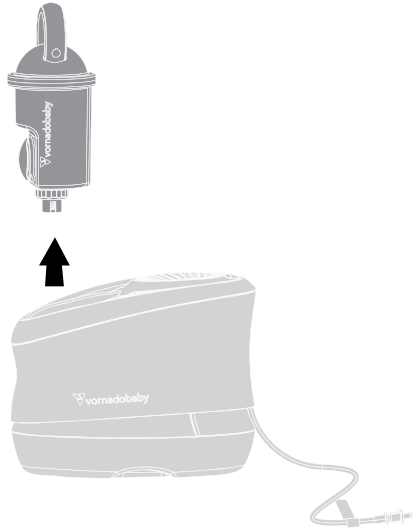

2. Choose a Water Bottle opening that is convenient for your sink. Remove Water Bottle Cap and fill Water Bottle with cool, clean water.

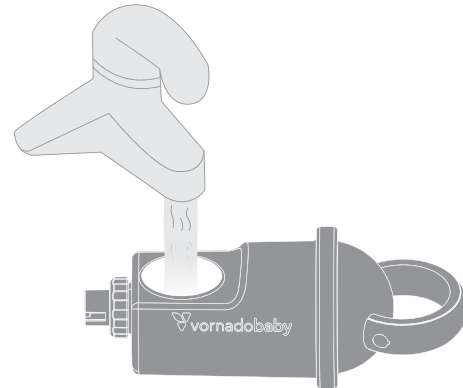
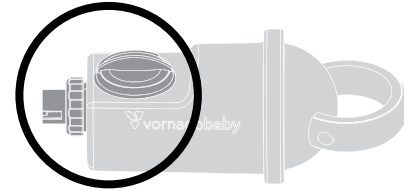

3. Replace Water Bottle cap and place Water Bottle inside Huey.

Note: Ensure the rubber ring around the Water Bottle Cap is properly positioned before replacing the Water Bottle Cap.

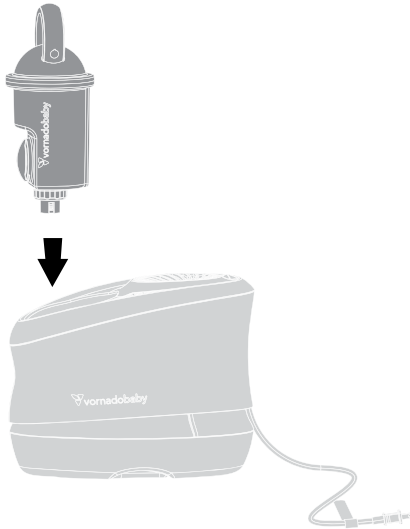

Note: Filling the Tank for the first time. The water inside the Water Bottle will drain into the base of Huey. After a few seconds you will notice the Water Bottle is 1/3 empty.

4. Repeat filling the Water Bottle with cool, clean water and replace Water Bottle inside Huey.

How To Use

Operation

1. Plug power cord into standard wall outlet.
2. Press the Power button On (⏻). The control panel will illuminate when On and dim after approximately 20 seconds.

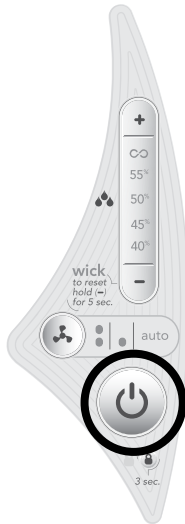

3. Select desired Humidity (💧) level, 40% to Continuous (∞), by the pressing (+/-) button. The Continuous level will output humidity continuously.

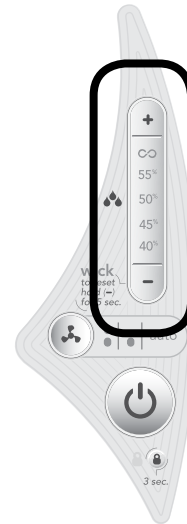

4. Select desired Fan (🌀) setting, Low (●), High (⦿) or Auto. Selecting Auto offers a more precise humidity control. Fan speed will fluctuate between high, low and off to better maintain set humidity level with a minimal amount of fan noise.

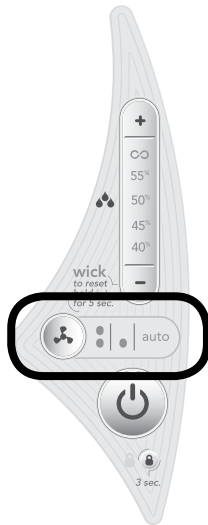

Note: Previous control settings are kept for the next time Huey is powered On, unless Huey is unplugged.

Huey features a child-resistant button, keeping Huey in parents' desired setting.

Lockable Controls

1. To engage this feature press and hold the Control Lock button (🔒) for 3 seconds. The Control Lock icon will blink 3 times rapidly to show it is locked.

Note: The Control Lock icon will blink 3 times slowly if any button is pressed while the Control Lock is engaged. While this feature is engaged you will not be able to change the settings or Power Huey Off. If Huey is powered Off, you may still engage the Control Lock.

2. To turn this feature off press and hold the Control Lock button (🔒) for 3 seconds.

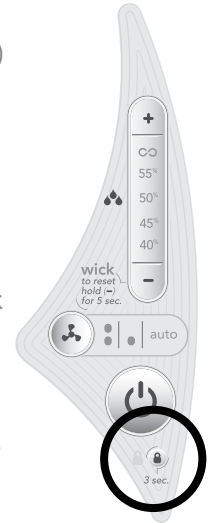

Changing Huey's Wick

While your Huey came equipped with a Wick, you will eventually have to replace it, after approximately 1,000 hours, depending on use. The word Wick will illuminate when it is time to replace the wick. Replace the Wick with only a genuine Vornado® brand Wick.

Replacing the Wick

1. Power Huey Off and unplug.
2. Remove Water Bottle.
3. Remove Huey top by lifting upward.

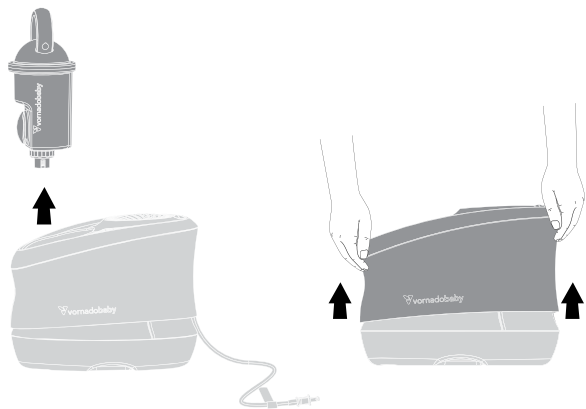

4. Discard used Wick and install a new genuine Vornado® Wick. Bend the Wick slightly when placing inside Huey.

Note: Make sure the Wick fits flush against the bottom and sides of Huey.

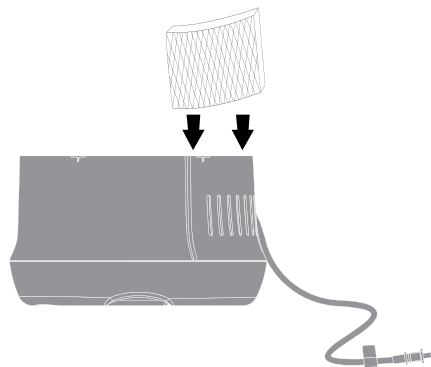

5. Replace Huey top and replace Water Bottle.

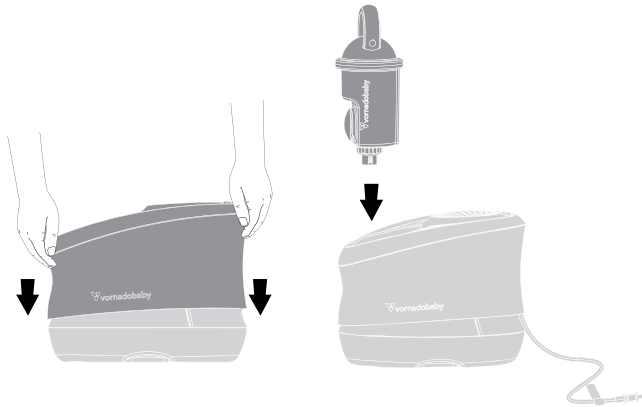

6. To reset Wick notification, press and hold (-) button for 5 seconds or until Wick is no longer illuminated.

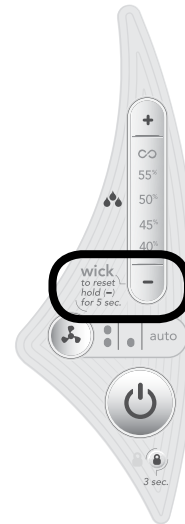

Extending Wick Life

Many factors affect the life of the Wicks, including amount of use, water hardness, and outside environmental factors.

1. The additional sodium in chemically softened water may cause Wicks to harden or become mushy. Try using untreated or tap water.
2. Hard water or water with excessive minerals such as lime or iron may shorten Wick life. Periodically remove the Wick and clean, by soaking them in cool tap water and two teaspoons of white vinegar for 20 minutes, then rinse in cool water. **DO NOT** wring.
3. If Huey is filled, do not leave it Off for more than 8 hours. Leaving the Wick too long in a filled Huey without the fan running may cause mold, mildew, and deterioration.

Automatic Refill Program

Select the shipment interval and Vornado will send replacement Wicks automatically. Eliminate the hassle of remembering to reorder. Maintain the high efficiency of your Vornado Huey.

To sign up, visit www.vornadobaby.com, email support@vornadobaby.com or call 1-800-234-0604. Cancel at anytime.



Model # MD1-0033

Keeping Huey Clean

Proper cleaning of your Huey is essential to the air quality and performance of your Huey. The frequency in which your Huey will need to be cleaned will vary, depending on use, water hardness, and outside environmental factors. It is recommended to thoroughly clean Huey several times throughout the season, or when algae, mineral deposits or other particles begin to form.

Disinfecting the Base

1. Power Huey Off and unplug.
2. Remove Water Bottle.
3. Remove Huey top by lifting upward.

Note: Do not submerge Huey in water. Do not place any parts in dishwasher.

4. Remove Wick.

①

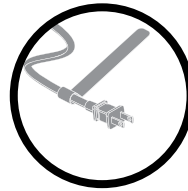

②

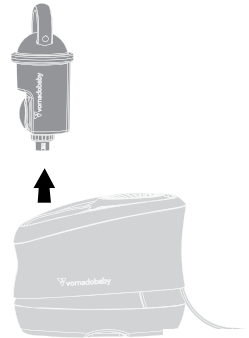

③

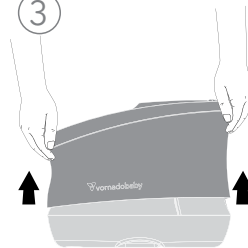

④

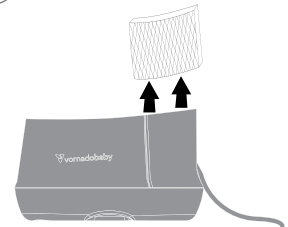

Always unplug Huey before starting any part of the cleaning process.

Keeping Huey Clean

5. Unlock base by rotating Lock Tab.

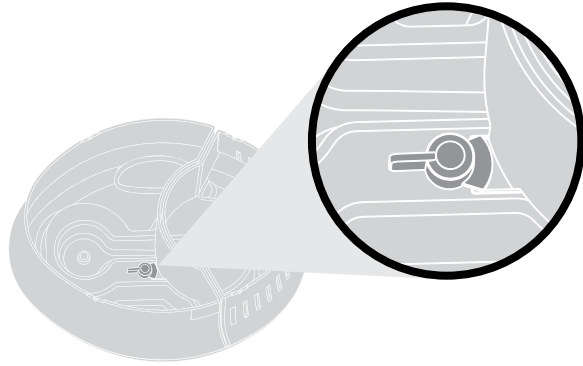

6. Gently detach side inlets from the base.

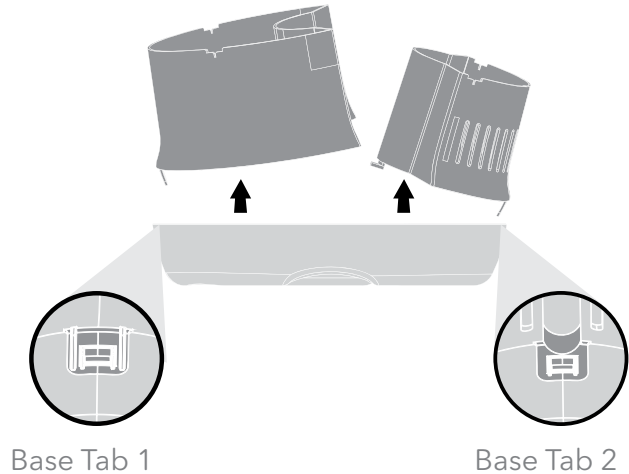

Always unplug Huey before starting any part of the cleaning process.

7. Clean the side inlets and any impurities in the base with a damp cloth.

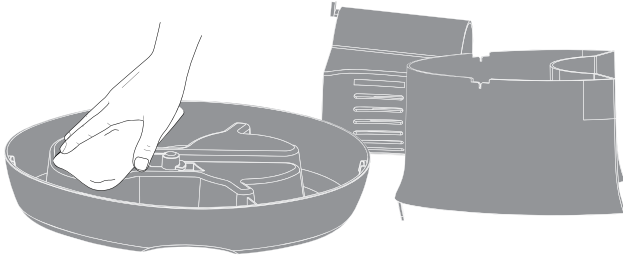

8. Replace side inlet by aligning along the sides of the base.

Note: Be sure each side inlet is locked inside the base tabs.

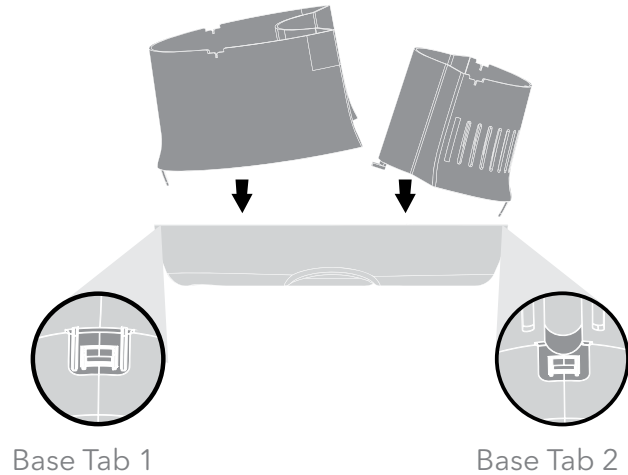

Always unplug Huey before starting any part of the cleaning process.

Keeping Huey Clean

Cleaning the Motor

1. Clean the underside of the motor by wiping away any impurities with a soft cloth.

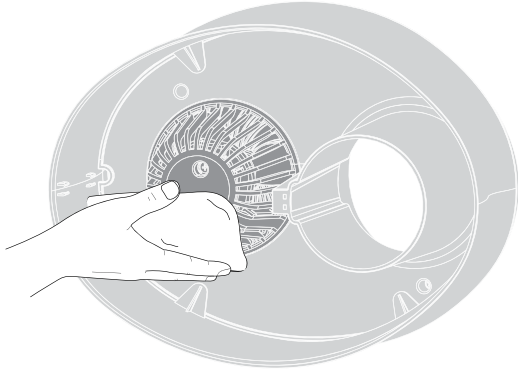

Cleaning Grill

1. Using a Phillips Head screwdriver, remove the screw located at the 3 o'clock position inside the grill.

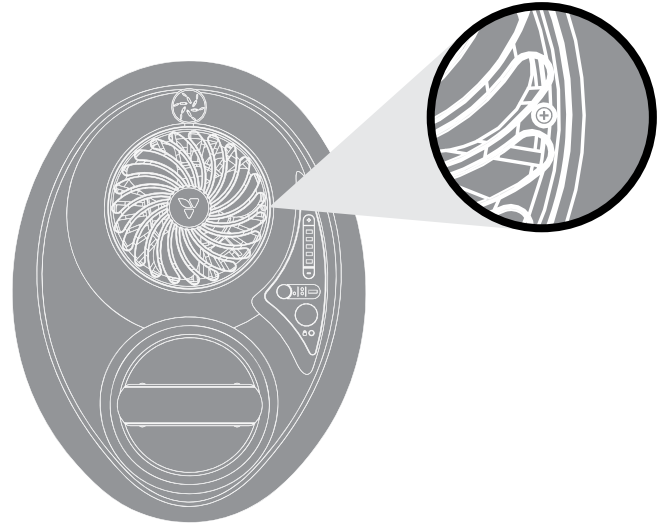

Always unplug Huey before starting any part of the cleaning process.

2. Twist Grill counterclockwise to unlock and lift upward.

Tip: Use the screwdriver to lift the Grill.

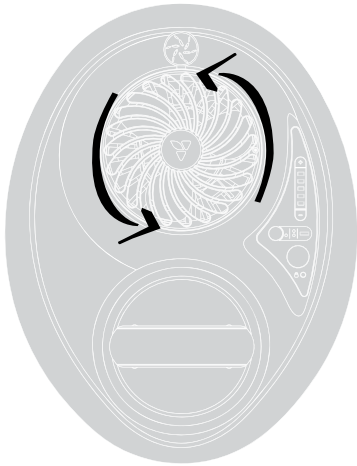

3. Clean any impurities on the Grill and Blade with a damp cloth.

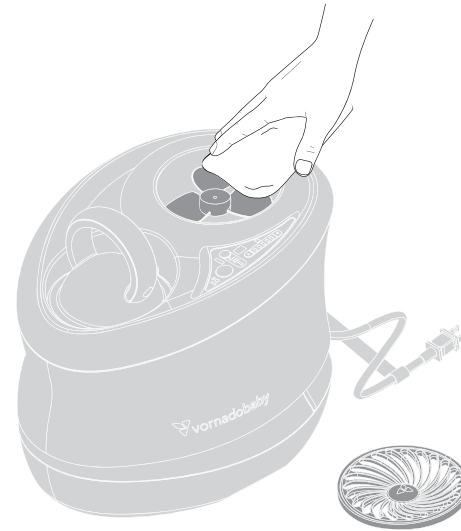

Note: Do not use gasoline, thinners, solvents or other chemicals for cleaning. Do not clean in dishwasher.

Always unplug Huey before starting any part of the cleaning process.

Keeping Huey Clean

Reinstall the Grill

1. Replace Grill onto Huey and twist clockwise until the Grill aligns with the screw hole. Replace screw.

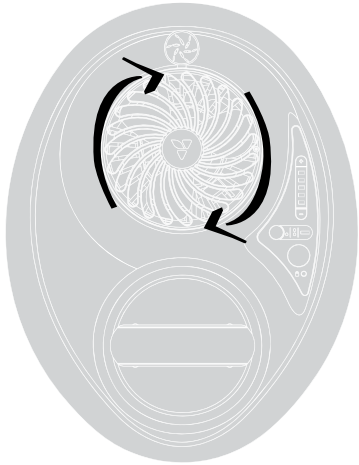

Always unplug Huey before starting any part of the cleaning process.

Tips

- During the off-season or after extended periods of non-use, you may choose to store your Huey. To ensure long life of the product, it is recommended to store your Huey by following these instructions:
 - Unplug power cord, wrap cord neatly and secure with Power Cord Wrap.
 - Thoroughly clean your Huey. Use the brush attachment on your household vacuum cleaner to vacuum any accumulated dust on Huey or wipe down the entire surface with a soft cloth. You may also use a can of compressed air for debris.
 - Cover, or place Huey back into retail carton if available. This will prevent Huey from accumulating dust over time.
 - Store Huey in a cool and dry location.
- Always set Power button to Off and unplug Huey before cleaning.
- The motor is permanently lubricated and requires no oiling. Do not use gasoline, thinners, solvents or other chemicals for cleaning.
- Your Huey has no user serviceable parts. Do not disassemble Huey. This will void your warranty. If service is required, return your Huey to Vornado (see WARRANTY for instructions).

Troubleshoot

Unit fails to power on.	Unit is not plugged in. Plug Power Cord into electrical outlet.
	Household circuit breaker / ground fault interrupter has tripped or blown a fuse. Reset circuit breaker / ground fault interrupter, or replace fuse. For assistance, contact a licensed electrician.
	Unit is damaged or in need of repair. Cease usage and unplug. Contact Consumer Service for assistance.
Unit makes a bubbling or gurgling sound.	This is normal. Water is being dispensed into Base.
Unit is not producing desired amount of humidity.	Water level in Tank is empty or too low. Refill with clean, cool tap water.
	Unit has reached its set point. When set humidity level is reached, the Fan will turn off until humidity level in the room drops below humidity set point.
	Airflow is blocked. Remove obstruction.

<p>Unit is not producing desired amount of humidity (cont.)</p>	<p>Unit settings are too low. Set to High Fan Speed and Continuous Humidity for maximum humidity output.</p>
<p>Wicks are in need of replacement too often.</p>	<p>The additional sodium in chemically softened water may cause Wicks to harden or become mushy. Try using untreated tap water or distilled water.</p>
	<p>Periodically remove the Wick and clean, by soaking them in cool tap water and two teaspoons of white vinegar. Let stand 20 minutes, then rinse in cool water. Allow excess water to run off and dry before replacing them in the Base. DO NOT wring.</p>



Happy Parent Guarantee

Call Toll Free
800.234.0604

www.vornadobaby.com
support@vornadobaby.com

Simply stated: If you're not satisfied with this product, let us know. We'll make it right.

Vornado Air LLC ("Vornado") warrants to the original consumer or purchaser this Vornadobaby® Huey Evaporative Vortex Humidifier ("Product") is free from defects in material or workmanship for a period of five (5) years from the date of purchase. If any such defect is discovered within the warranty period, Vornado, at its discretion, will repair or replace the Product at no cost.

For warranty or repair service:

Call 1-800-234-0604 or email support@vornadobaby.com to obtain a Return Authorization ("RA") form. Please have or include your Product's model number and serial number, as well as your name, address, city, state, zip code and phone number when contacting Vornado for warranty service.

After receiving the RA form, ship your Product to:

Vornado Air LLC Attn: Warranty & Repair 415 East 13th Street Andover, KS 67002. For your convenience, please have your model number and serial number when contacting Vornado with service inquiries. To assure proper handling, packages must be clearly marked with the RA number. Packages not clearly marked with the RA number may be refused at the receiving dock. Please allow 1-2 weeks for repair and return of your Product after the Product is received.

Product registration available online at www.vornadobaby.com

Repairs not covered by the warranty or outside the warranty period will require a fee to cover the cost of materials, labor, handling and shipping. This warranty does not apply to defects resulting from abuse of the Product, modification, alteration, repair or service of the Product by anyone other than Vornado, mishandling, improper maintenance, commercial use of the Product, damages which occur in shipment or are attributed to acts of God. REPAIR OR REPLACEMENT AS PROVIDED UNDER THIS WARRANTY IS THE EXCLUSIVE REMEDY OF THE CONSUMER. VORNADO SHALL NOT BE LIABLE FOR ANY INCIDENTAL OR CONSEQUENTIAL DAMAGES FOR BREACH OF ANY EXPRESS OR IMPLIED WARRANTY ON THIS PRODUCT. EXCEPT TO THE EXTENT PROHIBITED BY APPLICABLE LAW, ANY IMPLIED WARRANTY OF MERCHANTABILITY OR FITNESS FOR A PARTICULAR PURPOSE ON THIS PRODUCT IS LIMITED IN DURATION TO THE DURATION OF THIS WARRANTY. Some states do not allow the exclusion or limitation of incidental or consequential damages, or allow limitations on how long an implied warranty lasts, so the above limitations or exclusions may not apply to you. This warranty gives you specific legal rights, and you may have other rights that vary from state to state.



Designed, engineered and supported in Andover, KS

© 2015 Vornado Air LLC Andover, KS 67002 U.S. Patent Pending. Specifications subject to change without notice. Vornado® and Vornadobaby® are trademarks owned by Vornado Air LLC.