



model
ATOM 1S

OSCILLATING TOWER WITH
STAND OWNER'S GUIDE

vornado.com

We expect
this product
to be perfect.

If it is not,
we will make
it right.

vornado.com
800.234.0604
help@vornado.com

CONTENTS

Important Safety Instructions	4
Features	9
Getting Started	10
How to Use	15
Cleaning	18
Storage.....	19
Troubleshooting	20
Warranty.....	21

READ AND SAVE THESE INSTRUCTIONS

IMPORTANT SAFETY INSTRUCTIONS

This owner's guide and any additional inserts are considered part of the product. They contain important information about safety, use and disposal. Before using the product, please familiarize yourself with all operating and safety instructions. Please keep all documents for future reference and pass these documents on, together with the product, to any future owner. See www.vornado.com/circulators-manuals to view, download and print the most current version of these instructions.

INTENDED USE: This product is intended to circulate the air in indoor living spaces only in the United States and Canada. This product is not intended for commercial or industrial use. The manufacturer assumes no responsibility for damage or injury due to unauthorized use or product modification. Failure to follow these directions will void the product warranty.

WARNING: Risk to Children and Impaired Persons

Supervision is required during the installation, operation, cleaning and maintenance of this product by children 12 years of age and younger and anyone with reduced physical, sensory or mental capabilities. Children should be supervised to ensure that they do not play with the appliance, its parts and packaging material.

INSTALLATION WARNING—To reduce risk of fire, electrical shock and injury to persons, observe the following:

- Place this product away from curtains, draperies, tablecloths and other fabrics, since they may be drawn into the product, damage the motor and/or cause a fire.
- No part of this product (the appliance, power cord, plug, packaging, etc.) should be placed near furnaces, fireplaces, stoves or other high temperature heat sources. Do not use this product in a window, on an uneven or unstable surface, or near water.
- The appliance, power supply, power cord and plug cannot come into contact with water. Do not use this product on wet surfaces. Do not use this product in a bathtub or shower or position product where it may fall into a bathtub, laundry, swimming pool or other water container. Do not use this product outdoors or expose it to weather or elements.
- Do not run cord under carpeting. Do not cover cord with throw rugs, runners, or similar coverings. Do not route cord under furniture or appliances. Arrange cord away from traffic area and where it will not be tripped over. The cord should not hang over edges of counters or be placed where it can be crimped or closed in doors. Place appliance near an easily accessible outlet so the product can be unplugged quickly during an emergency.

SAFE USE WARNING—To reduce risk of fire, electrical shock and injury to persons, observe the following:

- **WARNING:** To reduce likelihood of circuit overload, fire and electric shock, do not operate with a solid state speed device, such as a dimmer control switch.
- Do not operate any fan with a damaged cord or plug. Discard fan or

- return to an authorized service facility for examination and/or repair.
- Do not operate unit if the unit has been dropped or damaged. Do not use this product if it has a damaged power supply or power cord. To avoid risk of electrical shock, do not attempt to repair or replace parts. Only original replacement parts may be used. If the power supply or cord is damaged, it must be replaced by the manufacturer, its service agent, or similarly qualified persons in order to avoid a hazard. Contact Vornado Consumer Service at 1-800-234-0604 (phone) or consumerservice@vornado.com (email) for further instructions about replacement and repair.
 - Risk of fire. Your appliance is equipped with a detachable power supply. Use only the power cord and plug provided. The detachable external power supply and cord have no user replaceable parts.
 - Before plugging power cord into electrical outlet, be sure that all electrical information on the rating label, including voltage, is compatible with your outlet's power supply.
 - Do not sit or stand on product.
 - Never use the cord as a handle or otherwise yank, strain or stretch the power cord.
 - While the product is plugged in, do not insert or allow foreign objects to enter any input or output opening as this may cause risk of electric shock or fire, or damage the product.
 - A loose fit between wall outlet (receptacle) and plug may cause overheating and distortion of the plug. Discontinue use of the product in this outlet. Contact a qualified electrician to replace loose or worn outlets.
 - Before moving, repositioning, servicing, cleaning and when not in use, use the product controls to turn off the power and then unplug. To disconnect

from outlet, grasp and pull only the plug. Also, power off and unplug if the product will be left unattended for an extended period of time or during electrical storms.

SERVICING WARNING—To reduce risk of fire, electrical shock and injury to persons, observe the following:

- Clean your product regularly, only as is instructed in this manual. Prior to cleaning, turn off the power on your product and unplug. Do not use gasoline, thinners, solvents, ammonias or other chemicals for cleaning. Refer to the CLEANING instructions provided.
- Do not open appliance housing while product is plugged in. To avoid risk of shock, all service and/or repairs must be done by a Vornado Authorized Service Center.
- Risk of fire. Do not replace attachment plug.

FCC Compliance Statement

This device complies with Part 15 of the FCC Rules. Operation is subject to the following two conditions: (1) This device may not cause harmful interference, and (2) this device must accept any interference received, including interference that may cause undesired operation.

NOTE: This equipment has been tested and found to comply with the limits for a Class B digital device, pursuant to Part 15 of the FCC Rules. These limits are designed to provide reasonable protection against harmful interference in a residential installation. This equipment generates, uses and can radiate radio frequency energy and, if not installed and used in

accordance with the instructions, may cause harmful interference to radio communications. However, there is no guarantee that interference will not occur in a particular installation. If this equipment does cause harmful interference to radio or television reception, which can be determined by turning the equipment off and on, the user is encouraged to try to correct the interference by one or more of the following measures:

- Reorient or relocate the receiving antenna.
- Increase the separation between the equipment and receiver.
- Connect the equipment into an outlet on a circuit different from that to which the receiver is connected.
- Contact Vornado Customer Service or dealer or an experienced radio/TV technician for help.

This Class B digital apparatus complies with Canadian ICES-003.
Changes or modifications not expressly approved by the party responsible for compliance could void the user's authority to operate the equipment.

Supplier's FCC Declaration of Conformity

Unique Identifier: Vornado Model ATOM 1S

Responsible Party: Vornado Air LLC

Mailing Address : 415 E. 13th St., Andover, KS 67002

Contact: www.vornado.com

SAVE THESE INSTRUCTIONS

FEATURES

FINGER FRIENDLY DESIGN

Resists curious fingers.

GESTURAL TOUCH-SENSITIVE CONTROLS

Simple controls with a sleek aesthetic.

MULTIPLE SPEEDS

4 speed settings for every comfort level.

ADJUSTABLE OSCILLATION

90°/180°/270°/360° or infinite oscillating airflow.

DC MOTOR

Quiet and energy efficient.

AUTO DIMMING DISPLAY

Reduces light pollution.

SILICONE FEET

Non-marking feet added for stability.

STAND (optional)

30" Stand / Base

Use stand only as intended.



GETTING STARTED

STAND ASSEMBLY *Screwdriver required.* 

1. Assemble one base plate (A) to the base mount (B). Press together until flush.

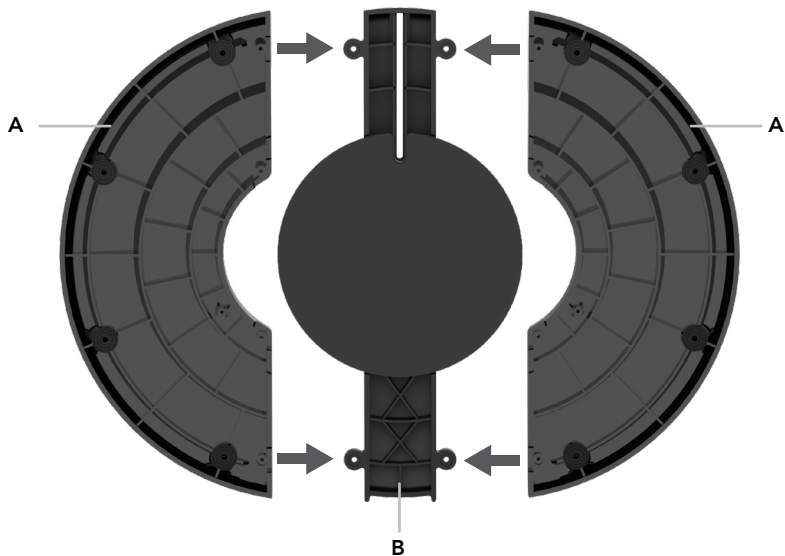

2. Using (5) five screws provided, secure the base plate (A) to the base mount (B).

3. Repeat on other side so that all (10) ten screws are installed.

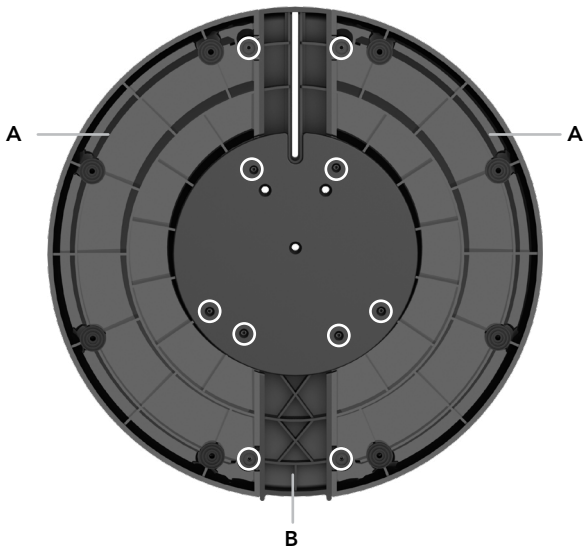

GETTING STARTED

STAND ASSEMBLY

4. Insert collar plug (C) into the top of the lower post (D) attached to the stand assembly.
5. Then insert the upper post (E) onto the collar plug.

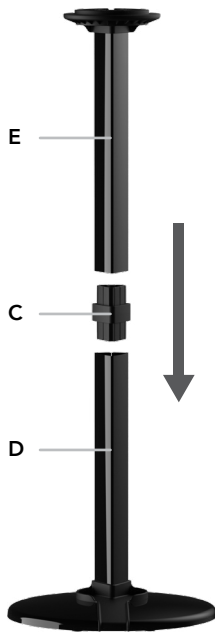

6. Attach your ATOM 1S on to the mount tray (F) using the (3) three captive screws.



7. Insert the DC power adapter cord connector (G) into DC receiver (H) located at the back of the product. Route the power cord through the recess on the back of the mount tray.

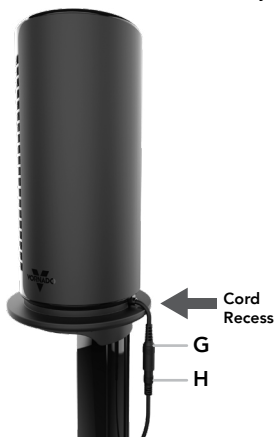

NOTE: If using stand, ensure stand is fully assembled and fan is fully secured to stand before use.

GETTING STARTED

STAND ASSEMBLY

8. Feed the power cord into the recess on the back side of the stand. Plug the power cord into a power outlet.

Your ATOM 1S is now fully assembled and ready for use.

NOTE: Be sure to place one hand on top and one hand on bottom of stand when moving the product. Do not attempt to carry product by fan head or mount tray only.



HOW TO USE

1. Touch (⏻) to power ON or OFF. Your circulator returns to last saved memory setting.
2. Select desired speed by pressing -/+ . Speed is indicated by number of white LEDs as shown on the display.

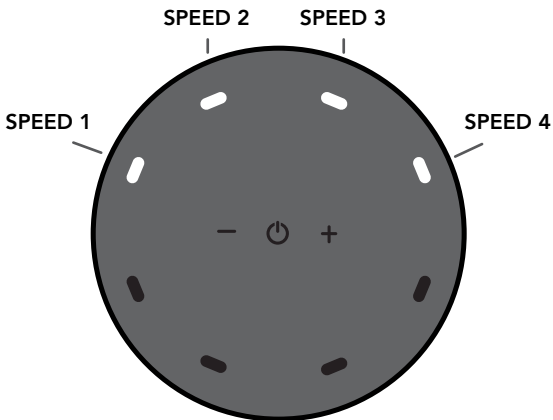

HOW TO USE

3. Swipe any area along the control panel perimeter to turn ON oscillation and select desired oscillation angle and direction of airflow. Select $90^{\circ}/180^{\circ}/270^{\circ}/360^{\circ}$ or infinite 360° oscillating airflow in either direction. The oscillation angle and direction of airflow is indicated by the blue LEDs as shown on the display.

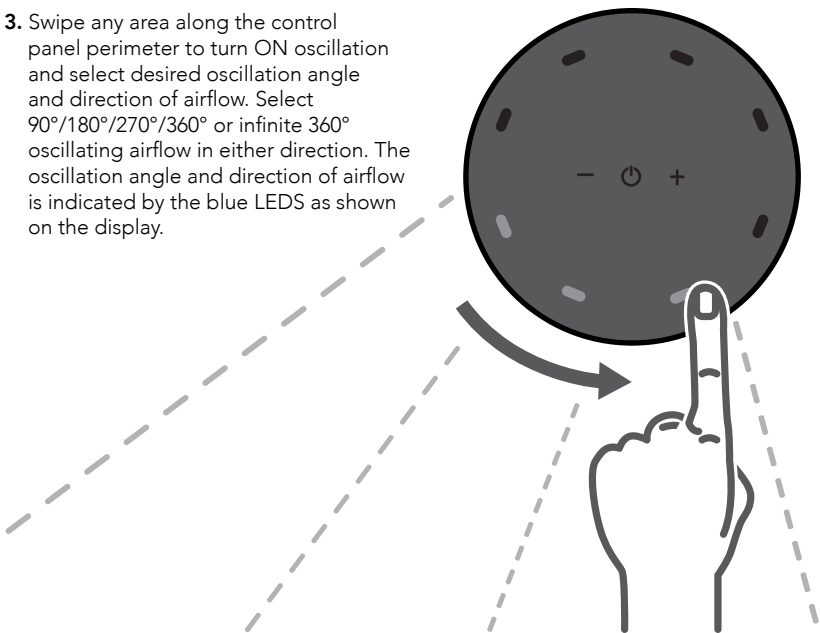

4. Press and hold any LED along the control panel perimeter for 2 seconds to turn OFF oscillation.
5. Double tap at any area along the control panel perimeter for targeted airflow. The airflow will then point where directed.

Note: The display will dim after 3 seconds of inactivity and reawaken with any touch to the control panel.

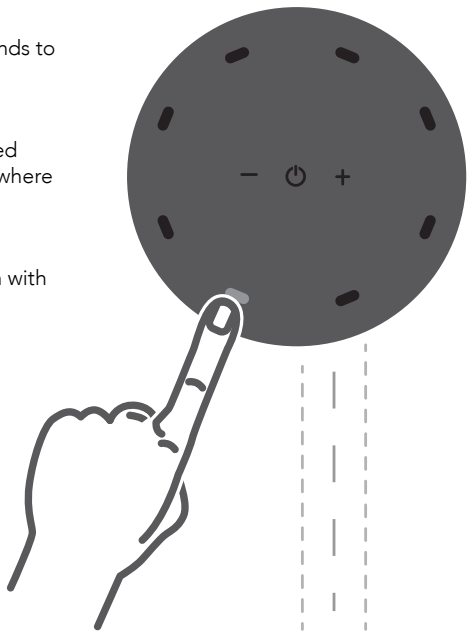

CLEANING

Because your ATOM 1S moves a substantial amount of air, it will need regular cleaning. The fan has no user serviceable parts inside and cannot be opened for cleaning. Never clean the product in any manner other than instructed in this owner's guide.

 **WARNING:** To reduce the risk of electrical shock and injury to persons, unplug the unit before cleaning.

1. Power off and unplug the unit prior to cleaning.
2. Dust or wipe the circulator and stand with a damp cloth.
3. Use the brush attachment on your household vacuum cleaner to vacuum any accumulated dust.

Note: The motor is permanently lubricated and requires no oiling.

STORAGE

During the off-season or after extended periods of non-use, you may choose to store your circulator. To ensure long life of the product, it is recommended to store your circulator by following these instructions:



Cleaning is recommended before storage.

1. Unplug power cord and bundle loosely.
2. Cover, or place back in retail carton if available. This prevents circulator from accumulating dust over time.
3. Store circulator in cool and dry location.

TROUBLESHOOTING

PROBLEM

POSSIBLE CAUSE AND SOLUTION

The unit fails to power on.

Unit is not plugged in. Plug Power Cord into electrical outlet.

Ensure unit fan speed setting is selected.

Unit is damaged or in need of repair. Cease usage and unplug. Contact Consumer Service for assistance.

The outlet is worn or damaged. Try another outlet or contact a qualified electrician.

Airflow is weak or slow.

Unit set to a low speed setting. Adjust to a higher speed setting.

Airflow is blocked. Remove obstruction.

Adjust direction of airflow towards the user.

GFCI has tripped.

Under certain conditions, it is possible for a reset GFCI (Ground Fault Circuit Interrupter) outlet to trip when the user is changing speeds on a Vornado circulator. In this event, change to an outlet that is not connected to a GFCI device. It could also indicate a weak or defective GFCI outlet. Contact a qualified electrician to check the GFCI outlet.



WARRANTY

We expect this product to be perfect. If you're not satisfied with this product, let us know.

We're Here To Help
800.234.0604
vornado.com
help@vornado.com

Vornado Air LLC ("Vornado") warrants to the original consumer or purchaser this Vornado® Personal Air Circulator ("Product") is free from defects in material or workmanship for a period of five (5) years from the date of purchase. If any such defect is discovered within the warranty period, Vornado, at its discretion, will repair or replace the Product at no cost.

For warranty or repair service: Call 1-800-234-0604 or email help@vornado.com to obtain a Return Authorization ("RA") form. Please have or include your Product's model number and serial number, as well as your name, address, city, state, zip code and phone number when contacting Vornado for warranty service. To file a contactless warranty claim, visit vornado.com/contact-us.

After receiving the RA form, ship your Product to: Vornado Air LLC Attn: Warranty & Repair 415 East 13th Street Andover, KS 67002. For your convenience, please have your model number and serial number when contacting Vornado with service inquiries. To assure proper handling, packages must be clearly marked with the RA number. Packages not clearly marked with the RA number may be refused at the receiving dock. Please allow 1-2 weeks for repair and return of your Product after the Product is received.

Repairs not covered by the warranty or outside the warranty period will require a fee to cover the cost of materials, labor, handling and shipping.



Designed, engineered and supported in U.S.A.

This warranty does not apply to defects resulting from abuse of the Product, modification, alteration, mishandling, improper maintenance, commercial use or repair or service of the Product by anyone other than Vornado; damages which occur in shipment or are attributed to acts of God. Improper product use, which includes using an external device that alters or converts the voltage or frequency of electricity, or shipping a Vornado product to a country not intended for use will void all warranties. Any unauthorized product modification, repair by unauthorized repair center, or use of non-approved replacement parts is not recommended and any consequences will not be covered by support services or product warranties. The product warranty will be honored only on models that are being used in the country intended. REPAIR OR REPLACEMENT AS PROVIDED UNDER THIS WARRANTY IS THE EXCLUSIVE REMEDY OF THE CONSUMER. VORNADO SHALL NOT BE LIABLE FOR ANY INCIDENTAL OR CONSEQUENTIAL DAMAGES FOR BREACH OF ANY EXPRESS OR IMPLIED WARRANTY ON THIS PRODUCT. EXCEPT TO THE EXTENT PROHIBITED BY APPLICABLE LAW, ANY IMPLIED WARRANTY OF MERCHANTABILITY OR FITNESS FOR A PARTICULAR PURPOSE ON THIS PRODUCT IS LIMITED IN DURATION TO THE DURATION OF THIS WARRANTY. Some states do not allow the exclusion or limitation of incidental or consequential damages, or allow limitations on how long an implied warranty lasts, so the above limitations or exclusions may not apply to you. This warranty gives you specific legal rights, and you may have other rights that vary from state to state. The manufacturer assumes no responsibility for damage caused by failure to follow these instructions or improper product use. Any such actions will invalidate the product warranty.

All company names and product names are trademarks of their respective owners. © All rights reserved. All technical information, data, and instructions for the installation, connection, and operation contained in these instructions for use correspond to the latest available information at time of printing. The contents of this manual may differ slightly from the actual product. Observe any additional supplements.

© 2022 Vornado Air LLC Andover, KS 67002 U.S. Patent Pending. Specifications subject to change without notice. Vornado® is a trademark owned by Vornado Air LLC.



Vornado Air, LLC
415 East 13th Street, Andover, Kansas 67002
800.234.0604 | vornado.com