



READ AND SAVE THESE IMPORTANT INSTRUCTIONS

Whole Room Air Circulator Owner's Guide

LEA Y TENGA EN CUENTA ESTAS INSTRUCCIONES IMPORTANTES

Guía del propietario del Circulador de Aire para toda la habitación

LIRE ET CONSERVER CES INSTRUCTIONS IMPORTANTES

Guide de l'utilisateur du ventilateur intégral de pièce

www.vornado.com

models VH102, 133, 160, 270,
360, 510, 530, 533, 573, 610, 630,
633, 660, 673, 679, 723, 733, 735,
743, 745, 753, 783, 795

Designed, engineered and supported in Andover, Kansas.

Pensado, diseñado y respaldado en Andover, Kansas.

Conception, mise au point et soutien technique effectués à Andover, au Kansas.

Questions or comments?
¿Preguntas o comentarios?
Questions ou commentaires?



www.vornado.com



consumerservice@vornado.com



800.234.0604

Important Instructions	4
Whole Room Circulation	6
Features and Benefits	7
Assembly.....	7
How To Use	8
Grill Removal.....	9
Blade Removal	12
Cleaning and Maintenance	12
Troubleshooting	13
Warranty.....	14

IMPORTANT INSTRUCTIONS

READ ALL INSTRUCTIONS BEFORE USING.

This appliance has a polarized plug. (One blade is wider than the other.) To reduce the risk of electrical shock, this plug is intended to fit in a polarized outlet only one way. If the plug does not fit fully in the outlet, reverse the plug. If it still does not fit, contact a qualified electrician. Do not attempt to defeat this safety feature.

WARNING – To reduce the risk of fire or electrical shock, do not use this product with any solid state speed control device. To reduce the risk of fire or electric shock and injury to persons, do not use in a window.

This product employs overload protection (fuse). A blown fuse indicates an overload or short-circuit situation. If the fuse blows, unplug the product from the outlet. Replace the fuse as per the user servicing instructions (follow product marking for proper fuse rating) and check the product. If the replacement fuse blows, a short-circuit may be present and the product should be discarded or returned to an authorized service facility for examination and/or repair.

- **Do** unplug your circulator before cleaning.
- **Do** clean your Vornado Air Circulator regularly. Refer to the CLEANING instructions provided. Never clean the air circulator in any manner other than as instructed in this manual.
- **Do Not** use gasoline, thinners, solvents, ammonias or other chemicals for cleaning.
- **Do Not** immerse this product in water or allow water to drip into the motor housing.
- **Do Not** use near furnaces, fireplaces, stoves or other high-temper-

ature heat sources.

- **Do Not** position this product too close to draperies because they may be drawn into the rear grill, cutting off airflow.
- **Do Not** use this product outdoors.
- **Do Not** use this product on wet surfaces.
- **Do Not** use this product in a bathtub or shower.
- **Do Not** operate any fan with a damaged cord or plug. Discard fan or return to an authorized service facility for examination and/or repair.
- **Do Not** carry this product by the cord, or use the cord as a handle.
- **Do Not** attempt to repair or replace parts.
- **Do Not** run cord under carpeting. Do not cover cord with throw rugs, runners, or similar coverings. Do not route cord under furniture or appliances. Arrange cord away from traffic area and where it will not be tripped over.
- **Do** use common sense when using this product and/or any electrical appliance.

User Servicing Instructions

Grasp plug and remove from the receptacle or other outlet device. Do not unplug by pulling on cord. Open fuse cover (A.) by sliding access cover on top of attachment plug towards blades. Remove fuse carefully (B.) by gently prying out the ends of the fuse from the receptacle.

Risk of fire. Replace fuse only with 2.5 Amp, 125 Volt fuse.

IMPORTANT INSTRUCTIONS

READ ALL INSTRUCTIONS BEFORE USING.

Contact Vornado customer service for replacement fuse.
Phone: 1-800-234-0604, email: consumerservice@vornado.com

Install replacement fuse (C.) by first placing the end of the fuse into the fuse receptacle which is opposite of the blades of the plug, then carefully push in the other end. Only push against the metal end of the fuse, not the glass center portion. Close the fuse access cover (D.) by sliding the cover back into the plug until it is completely closed, latches and is flush with the face of the plug. Risk of fire. Do not replace attachment plug. Contains a safety device (fuse, AFCI, LCDI) that should not be removed. Discard product if the attachment plug is damaged.

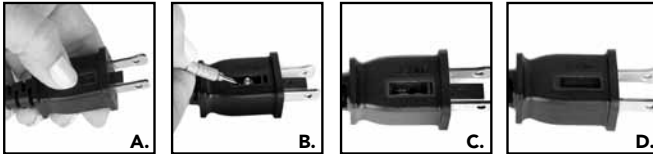

Models 660 & 270 only

Note: This equipment has been tested and found to comply with the limits for Class B digital device, pursuant to part 15 of the FCC Rules. These limits are designed to provide reasonable protection against harmful interference in a residential installation. This equipment generates, uses and can radiate radio frequency energy and, if not installed and used in accordance with the instructions, may cause

harmful interference to radio or television reception, which can be determined by turning the equipment off and on, the user is encouraged to try to correct the interference by one or more of the following measures:

- Reorient or relocate the receiving antenna.
- Increase the separation between the equipment and the receiver.
- Connect the equipment into an outlet on a circuit different from that to which the receiver is connected.
- Consult the dealer or an experienced radio/TV technician for help.

This device complies with part 15 of the FCC Rules. Operation is subject to the following two conditions: (1) This device may not cause harmful interference, and (2) this device must accept any interference received, including interference that may cause undesired operation.

This Class B digital apparatus complies with Canadian ICES-003. Cet appareil numérique de la classe B est conforme à la norme NMB-003 du Canada.

SAVE THESE INSTRUCTIONS

Trust.

It is said that trust isn't given, but earned. For decades Vornado has been earning the trust of our customers by offering them only the best. Vornado provides the highest level of performance, coupled with the highest level of support available. Complete satisfaction with no exceptions – this is Vornado's promise to you. If you are not satisfied for any reason, please contact us. Knowledgeable representatives are available at 1-800-234-0604 from 7:00 AM to 6:00 PM CST. A wealth of additional support is also available online at www.vornado.com. On behalf of myself and the entire staff at our Andover, Kansas headquarters – thank you for selecting Vornado.

Sincerely,
Bill Phillips
CEO, Vornado Air



Find our complete product line at www.vornado.com

Whole Room Circulation

Maximize your cooling efficiency.



Typical Fan

Vornado Air Circulator

A Vornado circulates all the air in the room so everyone is comfortable. Air in motion feels cooler than air that is stagnant. By providing whole room circulation, a Vornado allows you to turn the thermostat up 5° F - saving energy and money - without sacrificing comfort.

see it in action



VORTEX CIRCULATOR

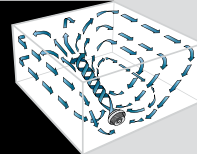

Feature



Multiple Speeds



Directable Airflow



Energy Savings



Adjustable Height

Benefit

With multiple speeds, any circulation need will be met. To turn on unit - rotate knob one position clockwise. Turn the knob clockwise to decrease airflow. Turn counterclockwise to increase airflow. On models equipped with push button speed controls: Press Power, then select speed.

Provides movement of air at any angle—up stairs, down a hallway, room to room and everywhere in between.

Models V102, 270, 573, 673 and 679 provide movement of air in two positions - vertically or horizontally.

Saves energy by maximizing the performance of heating and cooling systems. When you use a Vornado Air Circulator, you will not have to set your summertime thermostat as low or your wintertime thermostat as high.

(Model 783 and 795 only)

28" or 40" heights make this model perfect for out-of-the-way placement behind furniture and office furnishings. The extension tube must be used to achieve the 40" height. To shorten the height of the circulator, remove the extension tube. (See the Adjustable Height assembly instructions in the shipping carton.)

Installing Protective Feet

Use the feet to protect floors when using your air circulator on uncarpeted surfaces such as hardwood, vinyl, or tile. The feet are simple to install and will help maintain the whisper-quiet operation.

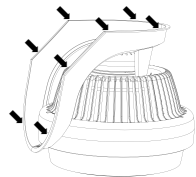
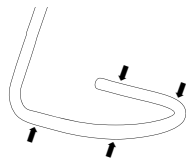

Cushion Ring Feet

(Models 723, 745, 783 and 795 only)

The cushion ring feet are packaged separately in the box. To install, roll or clip all feet onto the base and space evenly. For balanced support it is recommended to use 4 ring feet.

Cushion Pads

(Model 733 and 735 only)

Use guide marks on base bottom for location.

1. Place 4 pads over the 4 edge bends.
2. Place 2 pads on each of the curved ends.

Base Assembly

(Model 743 only)

1. Align the pins (A) located on each base piece and insert into the holes (B) on each base piece.
2. Align and insert pivot knob (C) into hole located on the base (D).
3. Place rubber washer (E) onto pivot knob. Then screw pivot knob into the head of unit (F) until secure. Repeat on opposite side of the base.

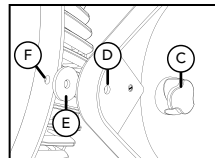
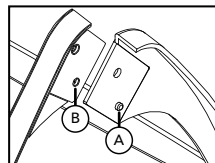

How To Use

When To Use – Saves Energy Year-Round

Summer: Use your Air Circulator with your home's air conditioning system to create brisk, comforting air movement. This breeze will eliminate stagnant air and remove body heat to make you feel cooler.

With Vornado Air Circulators, you can save money on energy bills by raising your thermostat several degrees and still maintaining the same comfort level.

Use with central
or window air
conditioning



Push cool air
up stairs

Spring & Fall: Your Air Circulator can make the indoors as fresh and pleasant as the outdoors. Place the Air Circulator near an open window, sliding door or French door to take full advantage of mild temperatures and seasonal breezes.

Circulate fresh
outdoor air



Even room
temperature

Winter: Position your Air Circulator in a place with unobstructed upward air movement. Run it only as fast as necessary to lower the heated air from the ceiling – but not fast enough to create a draft. Or, use your Air Circulator with other available heat sources (furnace vents, wood stoves or baseboard heaters) to circulate their warmth, taking full advantage of all available heat in the room. Do not point the Air Circulator at open flames.

Increase the
efficiency of
heating sources



Replace cold
floor air with
warm ceiling air

Getting Started

1. Position your Air Circulator so the beam of air has an unobstructed path from one side of the room to the other.
2. Set speed to medium and allow a few minutes for an airflow pattern to be established. (Different airflow patterns can be established by changing the location, angle and speed of the Air Circulator.)
3. Adjust the speed accordingly until a desired comfort level is achieved. You will quickly determine the precise amount of circulation required to maintain your personal comfort in a given room for the prevailing temperature and humidity conditions. Once you discover the added comfort of air circulation, you will use your Vornado Air Circulator season after season.

Where to Use

Air Circulator	Ideal Rooms
100, 300 and 500 series	Kitchen, Smaller Bedroom, Dorm Room, Office Cubicle
600 series	Den, Home Office, Hearth Room, Dining Room, Average Bedroom
660, V102, 270 and 700 series	Living Room, Master Bedroom, Family Room, Recreation Room Workshop/Hobby Room, Sunroom

Grill Removal

WARNING: To avoid risk of fire, electrical shock, or injury to persons, unplug the Air Circulator before removing the grill.

Models 510, 530, 610, 630, 723, 733, 743, 783, 735, 745, 795 • Remove the screw (only necessary on model 530). Depress one of the grill clips (A) by placing your thumb against the outside surface of the clip and pressing downward towards the motor, applying slight pressure forward. A flathead screwdriver can also be used if the clips are difficult to release. Usually by releasing one clip, the grill can be removed. If the grill cannot be removed, repeat the process on remaining clips. Replace by lining up the clips with the holes and firmly snapping the grill back into place. Replace the screw (model 530 only).

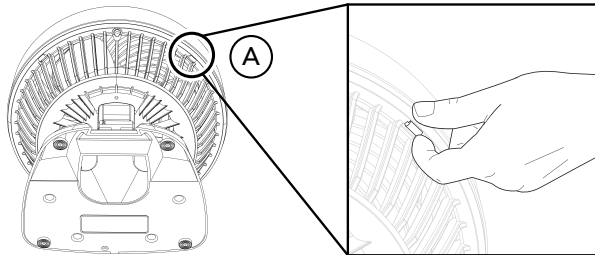
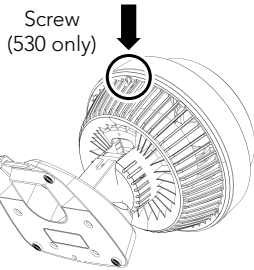

Models 533, 633, 753 • Remove the 3 screws located in between the ribs of the inlet grill at roughly 10, 2, and 6 o'clock positions. Screw locations are indicated by an arrow on the side of air inlet (B). **Do Not remove the 2 screws on the pivot arms.** Place the circulator facing you. Position your hands at the 10 and 2 o'clock positions, lift up and back on the outer grill to release the grill clips (C). If necessary repeat the process against the remaining two clips at the 5 and 7 o'clock positions. Replace by lining up the clips with the holes and firmly snapping the grill back into place. Replace all the screws.

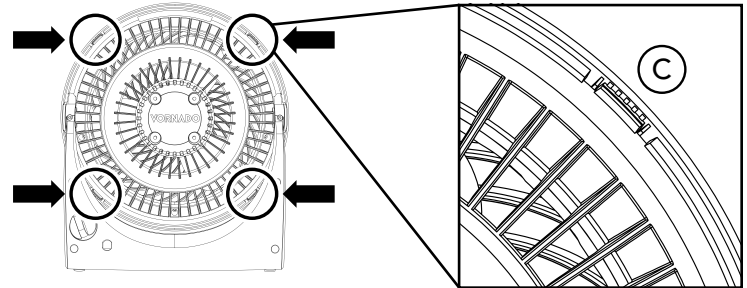
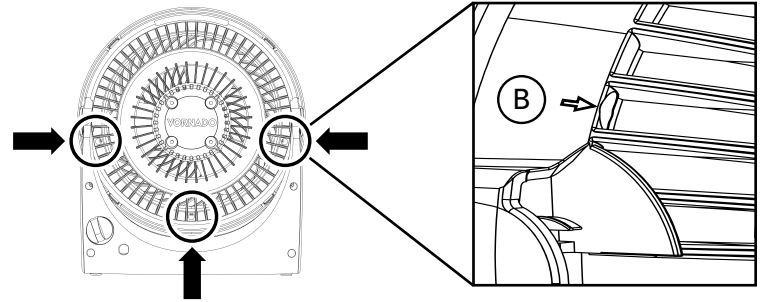

Grill Removal

Model 133 • Remove the 4 screws located at the back at the outer most edge of the inlet grill at roughly 2, 5, 7 and 11 o'clock positions, releasing the grill. To reattach - position the grill so the logo in the center of the grill is straight and replace screws.

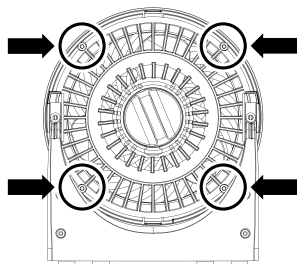

Model 160 • Remove the 4 screws located in between the ribs of the inlet grill at roughly 12, 3, 6 and 9 o'clock positions, releasing the grill. To reattach - position grill so the logo in the center of the grill is straight and replace screws.

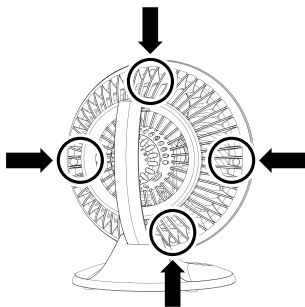

Model 360 • The grill on your model will be able to be removed in one of two ways. Check the back of your unit to see how many screws your unit has and follow the appropriate instructions.

Instruction A • Feel for bumps on back of product, close to inlets, that help to locate screws at roughly 12, 3, 6 and 9 o'clock positions. Remove the 4 screws located at these positions, releasing the grill. To reattach - position grill so the logo in the center of the grill is straight and replace screws.

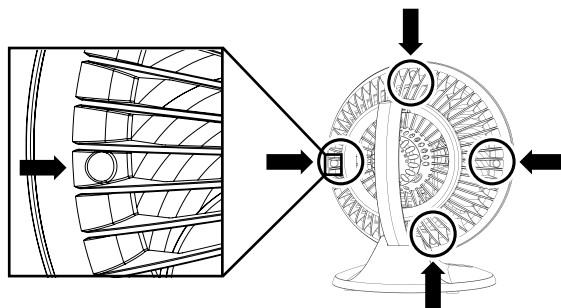

Instruction B • Remove the 2 screws located in between the ribs of the inlet grill at roughly 9 and 3 o'clock positions, releasing the grill. To reattach - position grill so the logo in the center of the grill is straight and replace the 2 screws.

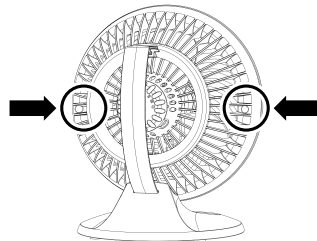

Grill Removal

Model 660 • The grill on your model will be able to be removed in one of two ways. Check the back of unit and follow **Instructions A** if you **do not** have buttons along the side. Follow **Instructions B** if you **do** have buttons along the side of unit.

Instruction A • Remove the 3 screws as indicated. Replace by lining up the holes and replacing all 3 screws securely into place.

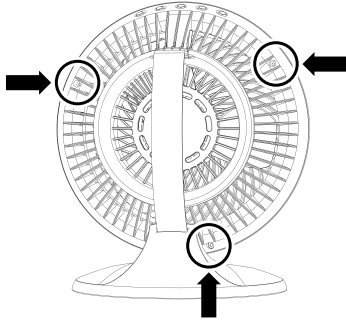

Instructions B • Remove screw on the bottom of head of unit on the left side of the chrome glide bar. Depress the 3 buttons (D) to release the grill. Replace by lining up the buttons with the holes and firmly snapping the grill back into place. Replace the screw.

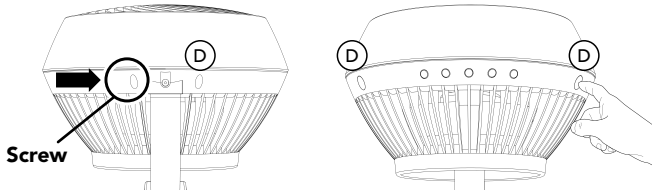

Models V102, 270 • Remove the screw located at the 6 o'clock position. Rotate the grill counter-clockwise to unlock and then lift off. To reinstall the grill, position the grill with the logo slightly turned to the left and rotate clockwise. Replace the screw.

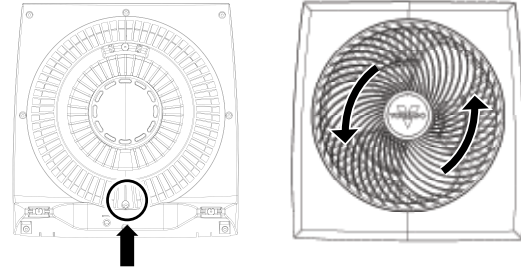

Models 573, 673, 679 • Remove the 8 screws around the perimeter of the frame and lift off. To reinstall the grill, line up screw holes and replace screws.

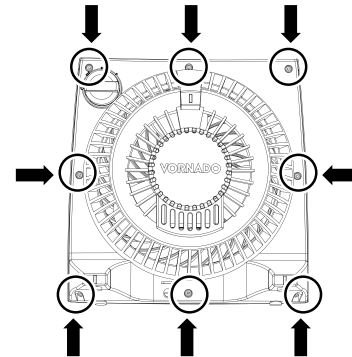

Blade Removal

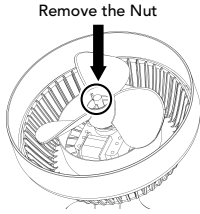

It is possible to remove the blade should something accidentally get wrapped around the motor shaft. First, remove the nut from the shaft (only necessary on V102, 133, 270, 573, 533, 633, 673, 679, 743 and 753 models.) Turn the nut **clockwise** to loosen. Pull the blade straight out from the shaft. When replacing, the blade can only go on the shaft one way. Be certain the flat side of the shaft aligns directly with the corresponding flat side on the blade's socket. Push the blade all the way on the shaft until it bottoms out. Do not use a hammer as this could result in bearing damage. Reinstall nut on applicable models.

Cleaning and Maintenance

Because your Air Circulator moves a substantial amount of air, it will need regular cleaning. To avoid risk of fire, electrical shock, or injury to persons, unplug the unit before any cleaning activity.



The motor is permanently lubricated and requires no oiling.

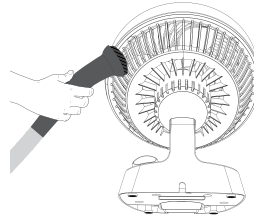

To clean motor cap and inlet ribs: Use a common household vacuum. Do not use water to clean these parts of the Air Circulator.

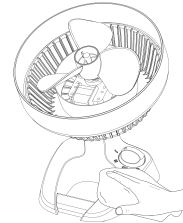

To clean grill: Remove grill (See GRILL REMOVAL instructions) and dust or wash with a mild dishwashing soap. Do not place grill in the dishwasher. The excessive heat can distort the plastic.

To clean blade: Wipe with a damp cloth. If your Air Circulator is used in a greasy environment, such as a kitchen, mild soap or a common household cleaner may be necessary. Do not use solvents.

To clean base: Wipe with a damp cloth.

Problem	Possible Cause and Solution
Unit fails to power on.	Unit is not plugged in. Plug Power Cord into electrical outlet.
	Ensure unit fan speed setting is selected.
	Plug fuse has blown. Replace fuse (See USER SERVICING INSTRUCTIONS on page 4).
	Unit is damaged or in need of repair. Cease usage and unplug. Contact Consumer Service for assistance.
	The outlet is worn or damaged. Try another outlet or contact a qualified electrician.
Airflow is weak or slow.	Unit set to a low speed setting. Adjust to a higher speed setting.
	Airflow is blocked. Remove obstruction.
	Adjust direction of airflow towards the user.



Whole Room Circulator • 5 Year Limited Warranty

Term: 10-Year Limited Warranty Models 735, 745, 795

5-Year Limited Warranty All Other Vornado Whole Room Air Circulator Models

Vornado Air LLC ("Vornado") warrants to the original consumer or purchaser this Vornado® Air Circulator ("Product") is free from defects in material or workmanship for a period of five (5) or ten (10) years from the date of purchase, depending on model. If any such defect is discovered within the warranty period, Vornado, at its discretion, will repair or replace the Product at no cost. Repairs not covered by the warranty or outside the warranty period will require a fee to cover the cost of materials, labor, handling and shipping.

This warranty does not apply to defects resulting from abuse of the Product, modification, alteration, repair or service of the Product by anyone other than Vornado, mishandling, improper maintenance, commercial use of the Product, damages which occur in shipment or are attributed to acts of God.

REPAIR OR REPLACEMENT AS PROVIDED UNDER THIS WARRANTY IS THE EXCLUSIVE REMEDY OF THE CONSUMER. VORNADO SHALL NOT BE LIABLE FOR ANY INCIDENTAL OR CONSEQUENTIAL DAMAGES FOR BREACH OF ANY EXPRESS OR IMPLIED WARRANTY ON THIS PRODUCT. EXCEPT TO THE EXTENT PROHIBITED BY APPLICABLE LAW, ANY IMPLIED WARRANTY OF MERCHANTABILITY OR FITNESS FOR A PARTICULAR PURPOSE ON THIS PRODUCT IS LIMITED IN DURATION TO THE DURATION OF THIS WARRANTY.

Some states do not allow the exclusion or limitation of incidental or consequential damages, or allow limitations on how long an implied warranty lasts, so the above limitations or exclusions may not apply to you. This warranty gives you specific legal rights, and you may have other rights that vary from state to state.

For warranty or repair service, call 1-800-234-0604 or email consumerservice@vornado.com to obtain a Return Authorization ("RA") form. Please have or include your Product's model number and serial number, as well as your name, address, city, state, zip code and phone number when contacting Vornado for warranty service. After receiving the RA form, ship your Product to:

Vornado Air LLC
Attn: Warranty & Repair
415 East 13th Street
Andover, KS 67002

For your convenience, please have your model number and serial number when contacting Vornado with service inquiries. To assure proper handling, packages must be clearly marked with the RA number. Packages not clearly marked with the RA number may be refused at the receiving dock.

Please allow 1-2 weeks for repair and return of your Product after the Product is received. For your records: Staple or attach your original sales receipt to this Owner's Guide. Please also write your products's serial number below (located on product specs decal).

Serial No. _____

Product registration available online at www.vornado.com

© 2009 Vornado Air LLC Andover, KS 67002

Patent Pending. Specifications subject to change without notice.

Vornado® is a trademark owned by Vornado Air LLC.

www.vornado.com consumerservice@vornado.com 800.234.0604



Vornado Air, LLC
415 East 13th Street, Andover, Kansas 67002
800.234.0604 | www.vornado.com

Speak your mind www.vornado.com/reviews
Hable con franqueza www.vornado.com/reviews
Évaluer ce produit en ligne www.vornado.com/reviews